



**RATINGS INFORMATION**

Supply Voltage	230-240V 50/60 Hz
Output Voltage	230-240V 50/60 Hz
Phase	Single / Two / Three
Max Total Current	63A max
Max Full-Phase Current	21A per phase
Rated Power Rating	6000 Watts
Model Number	SV4-01
IP Rating	IP68
Safety Standards	EN60335-1 / EN60335-2-85 AEN60335-1 / AEN60335-2-85

**WARNING**

- THIS APPLIANCE MUST BE SUPPLIED THROUGH A RESIDUAL CURRENT DEVICE (RCD) WITH A SENSITIVE OPERATING CURRENT NOT EXCEEDING 30mA.
- WARNING FOR INSTALLERS USE ONLY ON UNITS INSTALLED UNDER A REVERSE-POLARITY AIR SWITCH.
- WATER POWER MUST BE ISOLATED AND TURNED OFF BEFORE SERVICING THIS UNIT OR REPAIRING ANY TUBING CONNECTIONS.
- TO PREVENT ELECTRIC SHOCK, INSULATE WATER DAMAGE TO THIS APPLIANCE. ALL INSULATED REPAIRS MUST HAVE A WATER PROOF SEAL TO WATER.
- ANY DAMAGED CABLES ATTACHED TO THIS APPLIANCE MUST BE IMMEDIATELY REPLACED.
- THIS APPLIANCE MUST NOT BE INSTALLED IN PROXIMITY TO HIGHLY FLAMMABLE MATERIALS.

**SV4**  
ADVANCED SPA CONTROL  
variable heater

**WARNING! DANGEROUS VOLTAGE INSIDE**  
This product must be installed and maintained by qualified service personnel.

- 1. SET NUMBER OF PHASES (2P/3P/4P)**  
The number of phases is set by switching 1, 2 or 3 to select the number of phases 2, 3 or 4 respectively for operation. Refer back to the wiring (RCD) connection panel.
- 1. PREHEAT CIRCUIT BREAKER OPTION**  
1. Set preheat circuit breaker for system start up.  
2. Press to test (ON) preheat circuit breaker.  
3. Press (OFF) preheat circuit breaker when not required.  
4. Press (ON) preheat circuit breaker when required.  
5. Press (OFF) preheat circuit breaker when not required.



POWER SMART

SYSTEM OVERVIEW MANUAL

# SV SERIES USER MANUAL

## TABLE OF CONTENTS

### SYSTEM OPERATING MANUAL

Time/Date and Water Chemistry Warning.....	3
SV Series Features Overview .....	4
SV2.T Overview .....	5
SV3.T Overview .....	6
SV4.T Overview .....	7
Water Priming Mode .....	8
Display Modes .....	9

### KEYPAD OPERATION

Setting the Time and Day .....	10
Adjusting Set Temperature Point .....	11
Heater Operating Mode .....	12
Heating Control Protection .....	13
Pump Operation .....	14
Air Blower Operation .....	15
Light Operation (SV2.T models) .....	16
Light Operation (SV3.T / SV4.T models) .....	17
Sanitise Cycles .....	18
Special Function Buttons .....	19
Keylock .....	20

### ADVANCED CONFIGURATION SETTINGS

Setup Menu .....	21
Sleep Timers [SNZE] .....	24
Power Save Setting [P.SAV] .....	25
Error Codes / Troubleshooting .....	26
Heat Pump Error Codes / Maintenance Messages .....	28
Service Filters Scrolling Reminder (how to reset) .....	28
Contact Us .....	29

## WARNINGS

Please read the following before installing or connecting this appliance

- All electrical connections must be performed by a licensed electrician and must confirm to all national, state and local electrical codes in effect at the time of installation.
- The appliance should be supplied through a residual current device (RCD) having a rated residual operating current not exceeding 30mA.
- The appliance must be connected to a suitable rated and weather protected power supply. The supply line should be a dedicated power circuit and means for disconnection must be incorporated in the fixed wiring in accordance with your local wiring regulations. Means for disconnection from the supply mains should have a contact separation in all poles that provide full disconnection under over voltage Category III conditions.
- Earthed appliances must be permanently connected to fixed wiring (European models only).
- The appliance contains no serviceable parts. Do not attempt service of this control pack. Contact your dealer or authorised service agent for assistance.
- Turn the mains power OFF before servicing appliance or modifying any cable connection.
- Suitable for indoor use only or when installed under a weatherproof spa skirt. The appliance should be installed in an enclosure such that all electrical connections cannot be accessible to the user without the use of a tool.
- Low voltage or improper wiring may cause damage to this appliance. Read and follow all wiring instructions when connecting to power supply.
- Any damaged cable must be replaced immediately.
- To prevent electric shock hazard and/or water damage to this appliance, all unused receptacles must have a water proof seal in place.
- Parts incorporating electrical components must be located or fixed so that they cannot fall into the bath or spa.
- Parts containing live parts, except parts supplied with safety extra-low voltage not exceeding 12V must be inaccessible to a person in the bath or spa.
- This appliance must not be installed in proximity to highly flammable materials.
- Water temperature in excess of 38°C may cause hyperthermia (heat stress).
- It is the spa manufacturer's and/or installer's responsibility to select suitable loads and configure load shed settings (if required) to ensure the system does not exceed its rated maximum total load.
- It is the installer's responsibility to ensure the floor is capable of supporting the expected load of the bath or spa and an adequate drainage system has to be provided to deal with overflow water.
- A whirlpool spa should incorporate a water filtration system where the required level of water purity can be achieved.
- An adequate drainage system has to be provided if the equipment is to be installed in a pit.
- This appliance is not intended for use by persons (including children) with reduced physical, sensory or mental capabilities, or lack of experience and knowledge, unless they have been given supervision or instruction concerning use of the appliance by a person responsible for their safety.
- Children should be supervised to ensure that they do not play with the appliance.

## RISK OF ELECTRICAL SHOCK



## SET THE DATE AND TIME BEFORE USING THE SPA

Be sure to set the date and time before operating the spa (refer to page 10). Vital control functions require the time and date to be set correctly.

## WATER CHEMISTRY MAINTENANCE

It is your responsibility to regularly check and maintain the chemical water balance of the spa pool to ensure it remains within reasonable pH (acid/alkaline) limits (7.4 - 7.6 pH). Unbalanced water chemistry greatly accelerates corrosion and may lead to early product or component failure. **Product or component failures caused as a result of poor water chemistry maintenance will NOT be covered by the SpaNET Product Warranty.**

# SV Series Features Overview

## PowerSMART

Welcome to the eco-friendly world of power smart spa controls with the SV Series from SpaNET. Sophisticated real-time current sensing and variable heater technology allows the SV to make optimum use of any available power supply. Multi-phase capable the SV Series also provides flexibility with connection to mains power supplies supporting connection to 1,2 or 3 phases from 10 to 60A. Add in the host of exclusive PowerSMART energy saving features such as the dedicated heat pump interface, Dynamic Thermal Tuning, Off-Peak PowerSAVE software, and user-adjustable heating modes and the SpaNET SV Series stands apart from all rivals as the most power efficient spa control available that provides the lowest possible daily operating cost.

## Variable Heater

Most SV Series controller models feature SpaNET's innovative variable heater technology. With real-time current sensing the variable heater will automatically alter its power level (kW) to match the residual power available (amperage) after considering any operating accessory loads (i.e. jet pumps, air blowers). The benefit is that you can take advantage of a larger heater size for faster heat recovery and rest easy knowing this same heater will automatically reduce its size to maximise heating input when accessory loads are operating. The variable heater is automatically controlled and does not require adjustment. SV Series spa controller models that include the variable heater can be identified by a "-VH" suffix to the controller model number (i.e. SV3-VH).

## Heat Pump Interface

The SV Series spa controls are the first in the world to feature a dedicated expansion module for seamless integration of an energy efficient heat pump to the spa heating / cooling control system. The SV heat pump interface revolutionises spa temperature control. We can now offer both automatic heating and cooling of the spa water (from

10°C - 40°C) all conveniently controlled via the spa-side keypad, whilst also providing greatly reduced heat recovery times which can be further reduced with the exclusive SV element boost and fast heat up cycle options. The SpaNET SV heat pump technology maintains your spa's water temperature using around 75% less energy than a conventional electric heater resulting in an eco-friendly and amazingly cost efficient appliance. If connected, the heat pump will automatically be controlled by the SV Series spa controller. If the temperature is adjusted the control system automatically responds and will use the heat pump to heat or cool where required to regulate the water to the new set temperature point. With solid state diagnostics and real time heat pump monitoring the SV series control system correctly looks after every need of the heat pump ensuring long term reliability whilst delivering absolute minimum operating costs.

## Dynamic Thermal Tuning

No two spas are the same when it comes to thermal performance and heat retention. The SV control system will automatically adapt and tune itself to the thermal properties of your spa pool in its environment, day to day, season to season, to reduce demand heat cycling. Dynamic Thermal Tuning provides optimal thermal regulation whilst minimising power usage, resulting in lower daily operating costs.

## PowerSAVE (Off-peak filtration and heating)

Enjoy the benefits of greatly reduced off peak power tariffs to lower your spa's daily operating cost. The SV PowerSAVE technology controls automatic power consumption to off peak times whilst maintaining spa water temperature and daily filtration times. Simply enable PowerSAVE and set the tariff times and begin saving money.

# SV2.T Keypad Overview

Buttons and indicator LEDs

## DISPLAY MODE ICONS

- Water Temperature
- Set Temperature
- Clock

## MENU ICONS

- Sleep timer menu icon
- Light menu icon
- Blower menu icon

## STATUS ICONS

- Keypad locked
- Sanitise cycle operating
- Filtration cycle operating
- Fault condition has occurred

## UP BUTTON

Short single presses toggle through the three display modes: W.TMP = Water Temperature, S.TMP = Set Temperature, TIME = Clock.

Holding the button will force the controller to begin adjusting the set temperature and will raise the set temperature point.

Also used for adjusting settings.

## SANITISE BUTTON

Press once to activate a 20 minute sanitisation and clean up cycle to refresh water quality after spa use. A second press will cancel the cycle if already running.

## OK BUTTON

Used to confirm and save setting adjustments or to enter setting adjustment menus.

## WATER TEMP / TIME BUTTON

A shortcut key designed to quickly toggle between actual water temp and time display modes.

## DOWN BUTTON

Short single presses toggle through the three display modes: W.TMP = Water Temperature, S.TMP = Set Temperature, TIME = Clock.

Holding the button will force the controller to begin adjusting the set temperature and will lower the set temperature point.

Also used for adjusting settings.

## AUTOMATIC INDICATOR LED

This LED will turn on whenever the filtration pump is in automatic mode.

## HEATER INDICATOR LED

This LED will turn on when the heater or heat pump (if fitted) is operating.

## SANITISER INDICATOR LED

This LED will turn on to indicate that the ozone or uv sanitiser unit is operating (if fitted).

## SLEEP TIMER INDICATOR LED

This LED will turn on when the controller is in a sleep mode.

## PUMP A BUTTON

Used to toggle the filtration pump on / off / auto

## PUMP B BUTTON

Used to toggle any additional jet pump on / off (if fitted).

## BLOWER BUTTON

Press to toggle blower on/off. A single press turns blower on in vari-speed mode. Use up & down buttons to vary speed. A double press activates the ramping mode.

## LIGHT BUTTON

Press to toggle spa lights on / off. When light is first turned on the user has the ability to adjust the light effect mode or colour via the up, down & OK buttons.



# SV3.T Keypad Overview

Buttons and indicator LEDs

## DISPLAY MODE ICONS

- Water Temperature
- Set Temperature
- Clock

## MENU ICONS

- Sleep timer menu icon
- Light menu icon
- Blower menu icon

## STATUS ICONS

- Keypad locked
- Filtration cycle operating
- Sanitise cycle operating
- Fault condition has occurred

### AUTOMATIC INDICATOR LED

This LED will turn on whenever the filtration pump is in automatic mode.

### HEATER INDICATOR LED

This LED will turn on when the heater or heat pump (if fitted) is operating.

### SANITISER INDICATOR LED

This LED will turn on to indicate that the ozone or uv sanitiser unit is operating (if fitted).

### SLEEP TIMER INDICATOR LED

This LED will turn on when the controller is in a sleep mode.

**INVERT SCREEN BUTTON**  
Press to flip screen 180° for easy viewing when spa in use.

**PUMP (A,B,C) BUTTONS**  
Used to toggle filtration pump and / or any additional jet pump(s) on / off (if fitted).

**BLOWER BUTTON**  
Press to toggle blower on/off. A single press turns blower on in vari-speed mode. Use up & down buttons to vary speed. A double press activates the ramping mode.

**SANITISE BUTTON**  
Press once to activate a 20 minute sanitisation and clean up cycle to refresh water quality after spa use. A second press will cancel the cycle if already running.

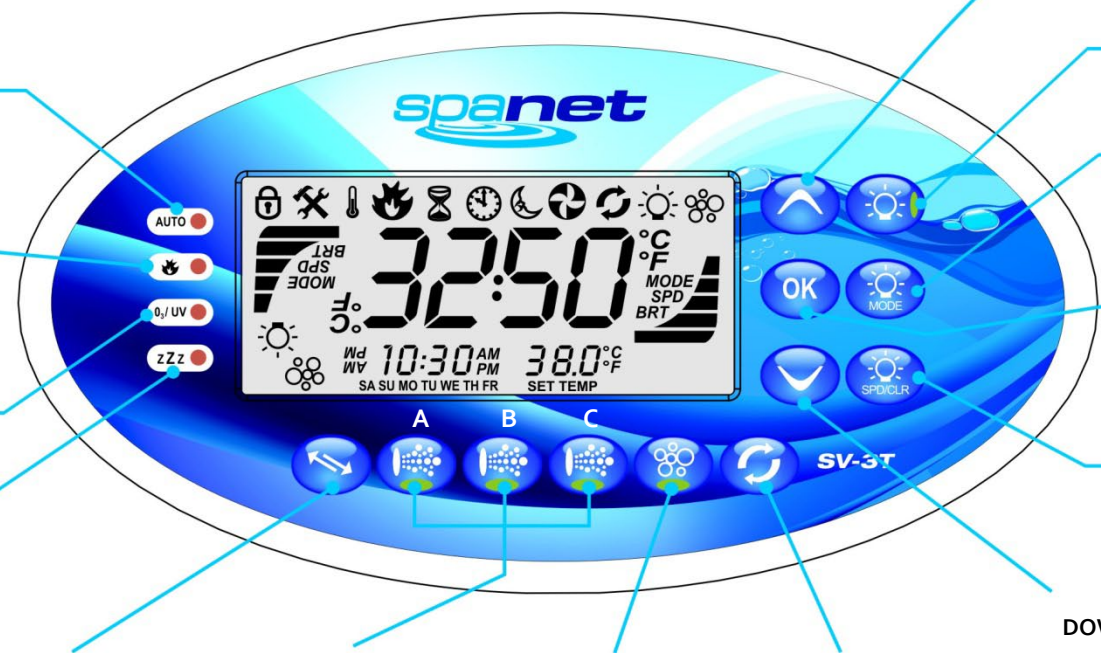

### UP BUTTON

Short single presses toggle through the three display modes: W.TMP = Water Temperature, S.TMP = Set Temperature, TIME = Clock.

Holding the button will force the controller to begin adjusting the set temperature and will raise the set temperature point.

Also used for adjusting settings.

### LIGHT (ON / OFF) BUTTON

Press to toggle spa lights on / off.

### LIGHT (MODE) BUTTON

Press to activate light mode menu & use up & down buttons to select one of five different lighting effect modes.

### OK BUTTON

Used to confirm and save setting adjustments or to enter setting adjustment menus.

### LIGHT (SPEED / COLOUR) BUTTON

Press to activate light speed or user colour selection menus. Use up & down buttons to adjust.

### DOWN BUTTON

Short single presses toggle through the three display modes: W.TMP = Water Temperature, S.TMP = Set Temperature, TIME = Clock.

Holding the button will force the controller to begin adjusting the set temperature and will lower the set temperature point.

Also used for adjusting settings.

# SV4.T Keypad Overview

Buttons and indicator LEDs

## DISPLAY MODE ICONS

- Water Temperature
- Set Temperature
- Clock

## MENU ICONS

- Sleep timer menu icon
- Light menu icon
- Blower menu icon

## STATUS ICONS

- Keypad locked
- Sanitise cycle operating
- Filtration cycle operating
- Fault condition has occurred

### AUTOMATIC INDICATOR LED

This LED will turn on whenever the filtration pump is in automatic mode.

### HEATER INDICATOR LED

This LED will turn on when the heater or heat pump (if fitted) is operating.

### SANITISER INDICATOR LED

This LED will turn on to indicate that the ozone or uv sanitiser unit is operating (if fitted).

### SLEEP TIMER INDICATOR LED

This LED will turn on when the controller is in a sleep mode.

### PUMP (A,B,C,D) BUTTONS

Used to toggle the filtration pump and / or any additional jet pump(s) on / off (if fitted).

### BLOWER BUTTON

Press to toggle blower on/off. A single press turns blower on in vari-speed mode. Use up & down buttons to vary speed. A double press activates the ramping mode.

### SANITISE BUTTON

Press once to activate a 20 minute sanitisation and clean up cycle to refresh water quality after spa use. A second press will cancel the cycle if already running.

### UP BUTTON

Short single presses toggle through the three display modes: W.TMP = Water Temperature, S.TMP = Set Temperature, TIME = Clock.

Holding the button will force the controller to begin adjusting the set temperature and will raise the set temperature point.

Also used for adjusting settings.

### LIGHT (ON / OFF) BUTTON

Press to toggle spa lights on / off.

### LIGHT (SPEED / COLOUR) BUTTON

Press to activate light speed or user colour selection menus. Use up & down buttons to adjust.

### OK BUTTON

Used to confirm and save setting adjustments or to enter setting adjustment menus.

### INVERT SCREEN BUTTON

Press to flip screen 180° for easy viewing when spa in use.

### DOWN BUTTON

Short single presses toggle through the three display modes: W.TMP = Water Temperature, S.TMP = Set Temperature, TIME = Clock.

Holding the button will force the controller to begin adjusting the set temperature and will lower the set temperature point.

Also used for adjusting settings.





## Water Priming Mode

Purge air from plumbing system



### TIPS ON FILLING SPA

- Before filling remove spa skirt and be sure that all valves in the plumbing system are fully open to maximise the amount of air that can escape the pipe work during filling
- Remove filter cartridge(s) before filling and be sure to fill the spa through the filter itself to flood the pipe work with water and minimise the chance of air pockets forming in the plumbing during the filling process.
- DO NOT fill spa by placing hose in the foot well. Filling a spa this way will create a large number of air pockets in the pipe work and may cause difficulty when priming. Always fill spa through the filter area.
- Once the spa is filled to the correct level attempt to power up the spa with the filter cartridges still removed. Verify that the spa controller completes its priming sequence and begins normal operation. Once normal operation has been verified turn mains power off, re-install filter cartridge(s) and restart spa.

### WARNING

**RESTRICTION OF WATER FLOW DUE TO DIRTY FILTER CARTRIDGES IS THE MOST COMMON CAUSE OF ER-3 FAULTS. IF THE SPA POOL HAS BEEN OPERATING NORMALLY THEN INTERMITTENT ER-3 FAULTS START TO OCCUR THE FILTER CARTRIDGE(S) WILL REQUIRE SERVICING.**

**DEPENDING ON TYPE OF FILTER CARTRIDGE(S) INSTALLED THE FILTERS WILL EITHER REQUIRE CLEANING, SOAKING IN A FILTER CARTRIDGE DEGREASER SOLUTION OR REPLACING. REFER TO SPA RESELLER / MANUFACTURER FOR DETAILS ON TYPE OF CARTRIDGE INSTALLED AND RECOMMENDED CLEANING FREQUENCY & METHODS.**

Every time the power is turned on the SV controller will initiate a water priming sequence on start up. During a priming sequence the filtration pump will run for up to 20 seconds at a time in an attempt to purge air from the plumbing. The keypad display will scroll PRIMING during this sequence.

If the spa controller is successful in clearing all of the air from the heater tube the system will begin normal operation. However if air is still detected the spa controller will shut down and latch on fault code (ER3-Water Prime).

### How do I solve ER-3 WATER PRIME:

- ▶ Press Pump A  button to retry water priming sequence
- ▶ Check spa is filled to correct operating level as advised by spa manufacturer (refill if necessary)
- ▶ Remove filter cartridge(s) and retry water prime
- ▶ With mains power turned OFF, bleed airlock from pipe work by slightly loosening couplings on front of filtration pump and allowing air to escape
- ▶ With filter cartridge(s) removed use hose to flush water down pipe work in an attempt to clear the air pockets from the plumbing

### IMPORTANT NOTE

*Do not allow the filtration pump to continue to run after five (5) x failed priming attempts. Operating a pump without water for extended periods may cause damage to the pump. Turn power off, wait ten (10) minutes and then try again later.*

*The in-heater water sensor constantly monitors the presence of water in the heater tube. If at any time air bubbles are detected the spa controller will automatically cancel all current operations and force a water priming sequence to begin. This will occur whether the spa is in automatic mode or manual use. If the priming sequence is successful in clearing the air pockets from the plumbing normal spa operation will resume in automatic mode. If unsuccessful the spa controller will shut down and latch on fault code ER-3 Water Prime.*

# Display Modes

Water Temperature / Set Temperature / Time

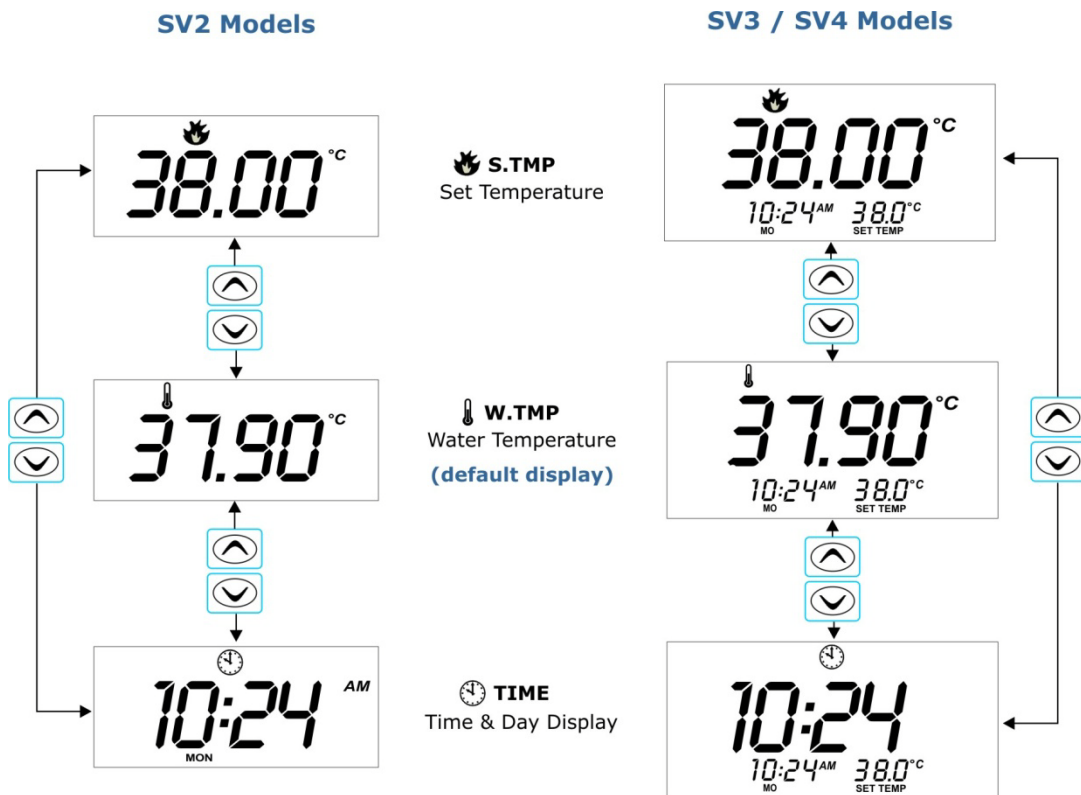

## IMPORTANT NOTES

- A ten (10) second idle time out period exists on non-default display modes. If the display mode is changed the screen will time out and return to the default display after ten seconds of idle activity has elapsed (i.e. no button presses).
- At times the WTMP icon will not appear and the temperature reading may take a while to update. This is normal and results from the SV control updating and performing dynamic thermal tuning to your spa and its environment. If this occurs, **the filtration pump may need to run for up to ten (10) minutes before the WTMP readout is refreshed.**

The SV keypads feature three different display modes to select from:

Mode	Icon	Description
W.TMP		Water Temperature
S.TMP		Set Temperature
TIME		Clock (Time & Day)

The default display mode for all SV controller models is (W.TMP) Water Temperature.

A short single press of the or button will navigate through the different display modes (refer illustrations aside).

The purpose of the different display modes is to allow easy set temperature point and clock adjustment on all SV<sub>2</sub>/SV<sub>3</sub>/SV<sub>4</sub> models.

Please note the display mode icon at the top of the screen. These icons denote what display mode is currently being viewed.

## Other Display Icons

- Filtration Cycle**  
The spa is performing a filtration cycle
- Sanitise Cycle**  
The spa is performing an automatic or manual sanitisation cycle
- Keypad Locked**  
The keypad has been locked
- System Error**  
A fault has been detected. The system has halted operation so that corrective action can be taken. Take note of scrolling error code and consult trouble shooting section of this manual.

# Setting the Date and Time

How to program the clock

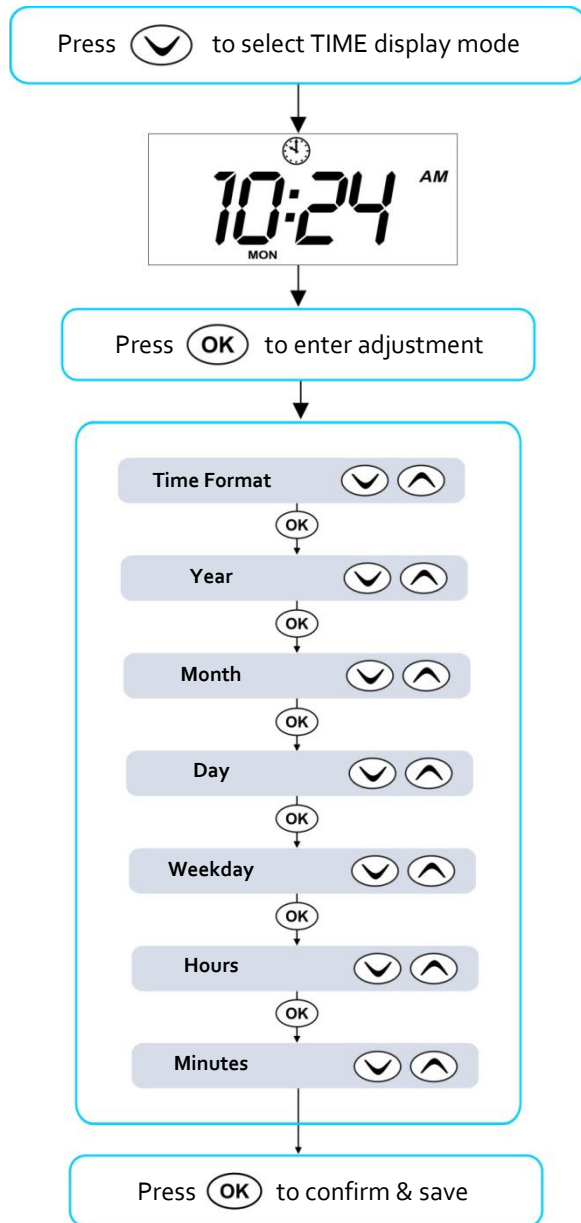

Be sure to set the date and time before operating the spa. Vital functions such as filtration, sanitisation cycles and power saving settings depend on the time and date being set correctly.

- ▶ Press the button to change display mode to TIME
- ▶ Press to enter clock adjustment
- ▶ The settings appear in the following order:

## TIME & DATE

- Format (24 hr / 12 hr)
- Year (yyyy)
- Month (mm)
- Day (dd)
- Weekday (mon – sun)
- Hours (xx:00)
- Minutes (00:xx)

- ▶ Press the or button
  - to set year, month, day, hours and minutes
  - to change between 24-hour format and 12-hour format
- ▶ Press the button to save each setting and move to the next setting

## IMPORTANT NOTES

- *Leap years are taken into account*
- *Daylight savings times are NOT taken into account. The clock will NOT automatically adjust. It must be changed manually*
- *The real time clock will continue to operate when mains power is off for a period up to 16 hrs*

## Adjusting Set Temperature Point

How to program the desired water temperature

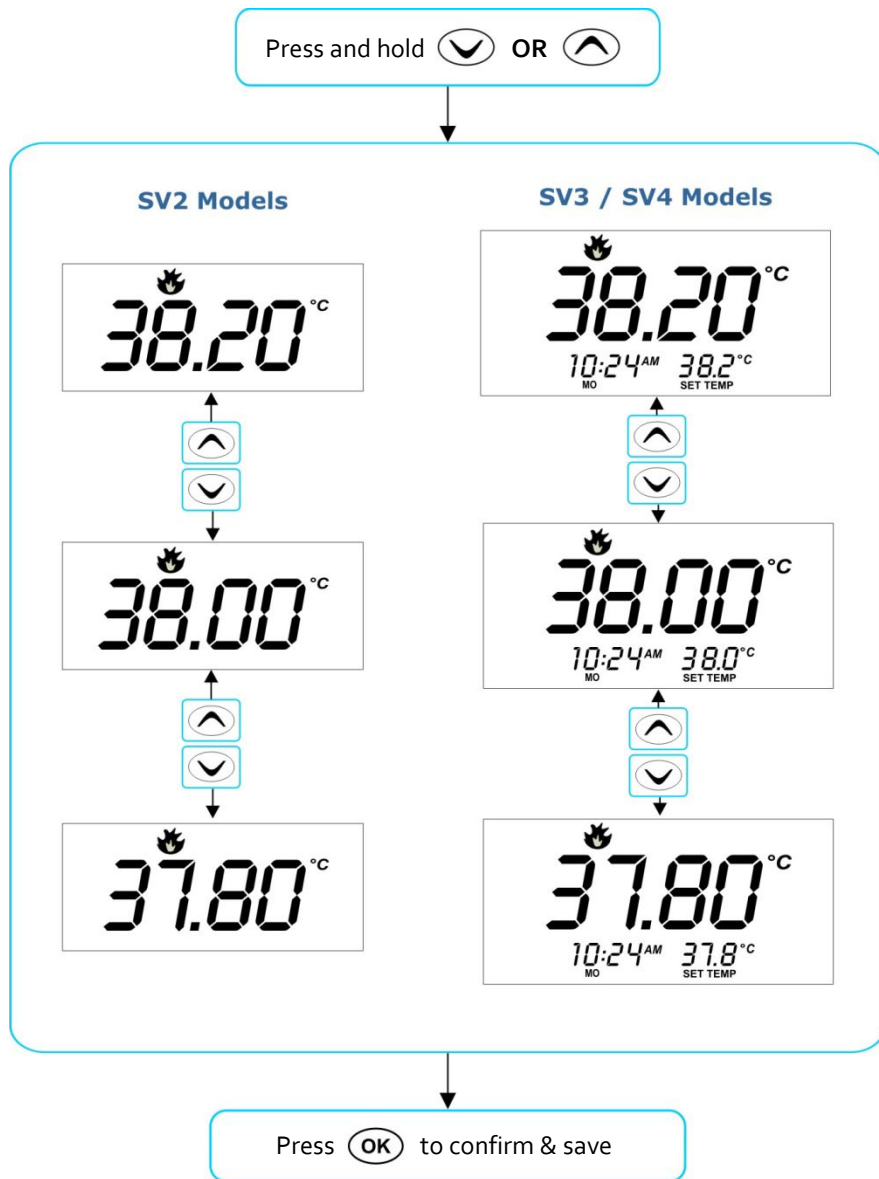

The SV series spa controllers have been designed with simplicity in mind. The intelligent software constantly monitors the spa water, automatically controlling the heater and/or heat pump (if fitted) to ensure the desired set water temperature is maintained and required level of daily filtration achieved.

With set-and-forget technology, the spa user simply selects their desired water temperature (Range: 10°C - 41°C; Default: 38°C) and thereafter the SV controller will automatically heat to and maintain that selected water temperature. This is called demand heating - the filtration pump and heater will be activated as required to maintain the set water temperature. The time spent heating the spa and running the pump under normal operation will be taken into account and where required the filtration pump will run for additional periods throughout the day to maintain the minimum level of daily filtration.

Dependant on the amount of normal spa use, set water temperature, daily filtration times, and climatic conditions being experienced, the SV controller will engage the heater and/or heat pump (if fitted) for differing periods of time, at differing times of day. The advanced software constantly monitors and recalculates after each heating / filtration cycle to ensure the correct daily filtration time is achieved and desired set water temperature is maintained.

Unless adjusted the SV controller will automatically heat to and maintain the default temperature of 38°C. The water temperature set point can be adjusted from 10°C to 41°C in steps of 0.2°C increments.

- ▶ Press and hold or to begin set temperature point adjustment
- ▶ The keypad numbers will flash during temperature adjustment
- ▶ Once desired set temperature point has been selected press to confirm

### IMPORTANT NOTES

- During a heating cycle the SV controller may raise the water temperature up to 0.6°C above set temperature point to provide an average water temperature of set point at most times.
- **If an optional heat pump is NOT fitted** the spa controller has **NO** ability to cool the spa water. Lowering the set temperature point will **NOT** cause the water to cool.
- **If an optional heat pump IS fitted** the spa water **CAN** be cooled as well as heated. Lowering the set temperature point will ensure the heat pump engages/disengages a cooling cycle (if required) to maintain the desired set water temperature.
- If the spa control has been in standby mode (idle) for some time and the set temperature point is adjusted, the filtration/circulation pump may run for up to ten (10) minutes before the heater / heat pump engages to heat or cool (heat pump only) the water.

## Heater Operating Modes

Normal / Economy / Away / Week Modes

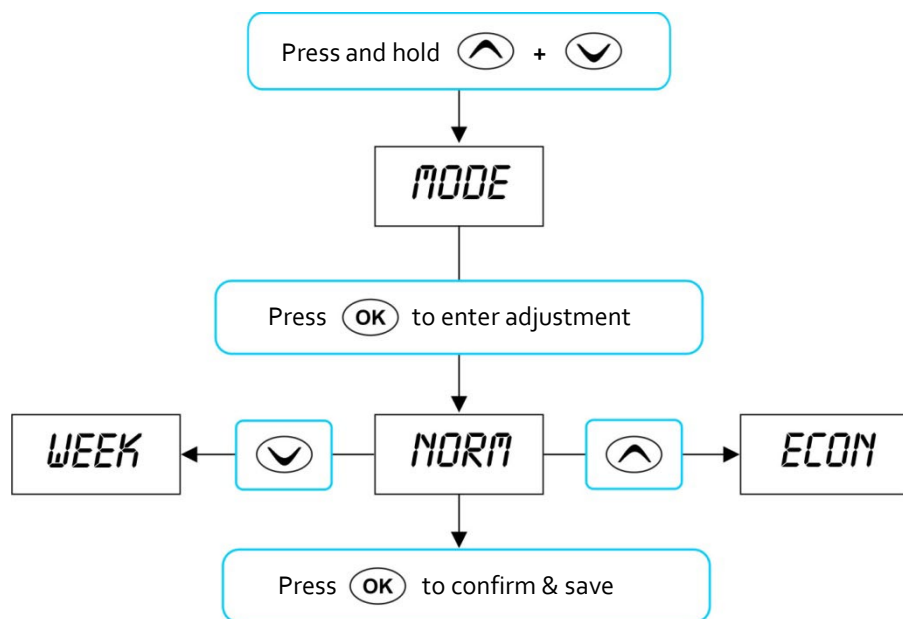

### IMPORTANT NOTES

- If Economy mode is selected and daily filtration time is set too low the spa water may not have sufficient heating time to reach set temperature point.
- If Away mode is selected all heating is completely disabled. The heater will not engage unless the water temperature falls below 4°C and freeze protection activates.
- If a heat pump is fitted and demand cooling is required to maintain the set water temperature, the demand cooling will also be governed by the heating operating modes in the same way that demand heating is.

## Heater Operating Mode

The SV controllers feature four different operating modes that effect demand heating and filtration behaviour (refer table below).

Item	Mode	Notes
NORM	Normal	Normal operation for demand heating and filtration
ECON	Economy	Demand heating can only occur when filtration pump is running
AWAY	Away	Demand heating is DISABLED. Filtration is fixed at 1 hour per day (the keypad will scroll "AWAY MODE" every 60 secs)
WEEK	Week	Monday to Thursday: Demand heating is DISABLED and filtration fixed at 1 hour per day. Friday to Sunday: Normal Operation

- ▶ Press and hold and buttons together until [MODE] is displayed
- ▶ Press button to enter operating mode (MODE) adjustment
- ▶ Press or to select desired operating mode
- ▶ Press button to confirm and save setting

### IMPORTANT NOTES

- The Week mode is ideal for spas used only on weekends or located at weekend holiday homes. To minimize operating costs during the week (when the spa will not be used) demand heating is disabled and filtration is reduced to 1 hour per day. During Friday, Saturday and Sunday the spa controller will operate as if in normal mode.
- If Week mode is selected, the spa controller will obey all programmed values (set temperature, sleep timers, power save timers, filtration etc) on Friday, Saturday and Sunday. Depending on current season and ambient temperatures the spa water temperature may fall significantly during Monday to Thursday when demand heating is disabled. The spa user must take into consideration all programmed settings including sleep timers and power save timers for the spa to have sufficient time to reheat to set temperature point on Friday (refer page 20 Setup Menu for further details on programmable settings).

# Heating Control & Protection

Fast Heat Cycle / freeze and overheat protection

## Fast Heat Cycle

After initial mains power on the SV controller will perform a fast heat up cycle that enables continuous demand heating regardless of programmed sleep timers or choice of Economy (ECON) or Normal (NORM) heating modes. Once the set temperature has been reached the fast heat up cycle is cancelled and normal operation resumes.

The purpose of a fast heat up cycle is to help the spa reach set temperature as soon as possible after it has been powered up. For new spas or spas refilled with cold water it is desirable not to have sleep time or economy heating mode delay the time to takes for the spa to reach set temperature point.

**Note:** AWAY mode disables a fast heat up cycle.

### IMPORTANT NOTES

- *A fast heat up cycle is cancelled by manually forcing the filtration pump to OFF via the keypad.*
- *For new spas or when a spa has just been refilled it is common for spa owners to test the operation of each pump when the power is first turned on. This process will effectively cancel the fast heat up cycle. After completing testing of spa functions remember to reset mains power if you wish to reactivate the fast heat up cycle.*

## Freeze Protection

Freeze protection will be activated whenever the water temperature drops below 4°C. It runs back to back 10 minute sanitise cycles and displays "WARM" on the LCD. It also runs each spa accessory (ie. jet pumps and air blower) in sequence to run water through the pipe work whilst running the filtration pump and heater. During the "WARM" cycle the heater and heat pump (if fitted) will operate however heater load shedding may occur when accessory pumps are running depending on controller settings.

At the end of each 10 minute "WARM" cycle the water temperature is checked. If it is above 4°C freeze protection stops and the controller returns to its prior state. If the temperature is not above 4°C another cycle will run.

**Note:** Freeze protection overrides sleep time or power save times – if the water temperature drops below 4°C and the controller is in a sleep period it will wake up. So even if high amounts of sleep time, power save time and a low set temperature point have been programmed, the SV controller will always maintain the water temperature at least above 4°C.

## Defrost Cycle (Heat Pump models only)

During periods of low ambient temperatures defrost cycles may be required to prevent the heat pump's condenser from freezing. Ambient and condenser temperatures are constantly monitored and defrost cycles will be automatically activated if certain conditions are met. Defrost cycles run for a minimum of 3 minutes to a maximum of 10 minutes.

## Overheat Protection

All SV controllers feature three forms of overheat protection:

- If sensed water temperature within the heater unit exceeds safe working limits the heating element will be disabled and the controller will shut down and latch fault code (ER4 - Thermal Trip). Normal operation will not resume until heater element has cooled and mains power is reset
- If sensed water temperature exceeds 42°C filtration is stopped until the temperature falls below 42°C to prevent heat rise from filtration pump operation
- If sensed water temperature exceeds 45°C the controller will shut down and latch fault code (Er5 - Pool too hot). Normal operation will not resume until mains power is reset

# Pump Operation

Keypad pump button assignments

PUMP CONFIGURATIONS					
MODEL	CIRC	PUMP1	PUMP2	PUMP3	PUMP4
SV2	no	1 spd	-	-	-
SV2	no	2 spd	-	-	-
SV2	yes	1 spd	-	-	-
SV2	yes	2 spd	-	-	-
SV3	no	1 spd	1 spd	-	-
SV3	no	1 spd	1 spd	1 spd	-
SV3	no	2 spd	n/a	1 spd	-
SV3	yes	1 spd	1 spd	-	-
SV3	yes	1 spd	1 spd	1 spd	-
SV3	yes	2 spd	n/a	1 spd	-
SV4	no	1 spd	1 spd	1 spd	1 spd
SV4	no	2 spd	n/a	1 spd	1 spd
SV4	no	2 spd	n/a	2 spd	n/a
SV4	yes	1 spd	1 spd	1 spd	1 spd
SV4	yes	2 spd	n/a	1 spd	1 spd
SV4	yes	2 spd	n/a	2 spd	n/a

BUTTON ASSIGNMENTS			
PUMP A	PUMP B	PUMP C	PUMP D
pump1 (on/off/auto)	-	-	-
pump1 (low/off/auto)	pump1 (high/low)	-	-
circ pump (on/off/auto)	pump1 (on/off)	-	-
circ pump (on/off/auto)	pump1 (low/high/off)	-	-
pump1 (on/off/auto)	pump2 (on/off)	-	-
pump1 (on/off/auto)	pump2 (on/off)	pump3 (on/off)	-
pump1 (low/off/auto)	pump1 (high/low)	pump3 (on/off)	-
circ pump (on/off/auto)	pump1 (on/off)	pump2 (on/off)	-
pump1 (on/off)	pump2 (on/off)	pump3 (on/off)	-
circ pump (on/off/auto)	pump1 (low/high/off)	pump3 (on/off)	-
pump1 (on/off/auto)	pump2 (on/off)	pump3 (on/off)	pump4 (on/off)
pump1 (low/off/auto)	pump1 (high/low)	pump3 (on/off)	pump4 (on/off)
pump1 (low/off/auto)	pump1 (high/low)	pump3 (low/off)	pump3 (high/low)
pump1 (on/off)	pump2 (on/off)	pump3 (on/off)	pump4 (on/off)
circ pump (on/off/auto)	pump1 (low/high/off)	pump3 (on/off)	pump4 (on/off)
circ pump (on/off/auto)	pump1 (low/high/off)	pump3 (low/high/off)	-



## Pump Buttons

The jet pumps and/or filtration pump are controlled via the pump buttons on the keypad. The functions of the pump buttons change depending on pump configuration, however Pump-A button is mostly used to control the filtration pump.

The intention is to make best possible use of these buttons for all possible pump configurations. For every press of a pump button the display will temporarily show the selected pump state:

**ON / OFF / LOW / HIGH / AUTO**

and then revert to the default display mode. The most common pump configurations and button assignments are referenced in the table aside.

### IMPORTANT NOTES

- *In configurations where a pump button controls the filtration pump and the heater is ON and pump is to be turned OFF; the pump will turn OFF after a 5 second delay to allow the heater to cool down.*
- *If left running, pumps will turn off after a 30 minute time out period. Time out period can be adjusted from 10 to 60 minutes via the Setup Menu item T.OUT (refer page 21).*
- *If after manual spa use filtration pump is left OFF, controller will revert to automatic mode 15 minutes after the expiry of the T.OUT period.*

### IMPORTANT NOTE

*In some configurations if heater is ON, activating multiple pumps may cause the heater to load shed and turn OFF, or reduce element power (variable heater models). This is to keep the system within its maximum current limit. The heater will be re-engaged or returned to full capacity as soon as the number of pumps running is reduced.*

# Air Blower Operation

Blower button functions

## Variable Speed Mode

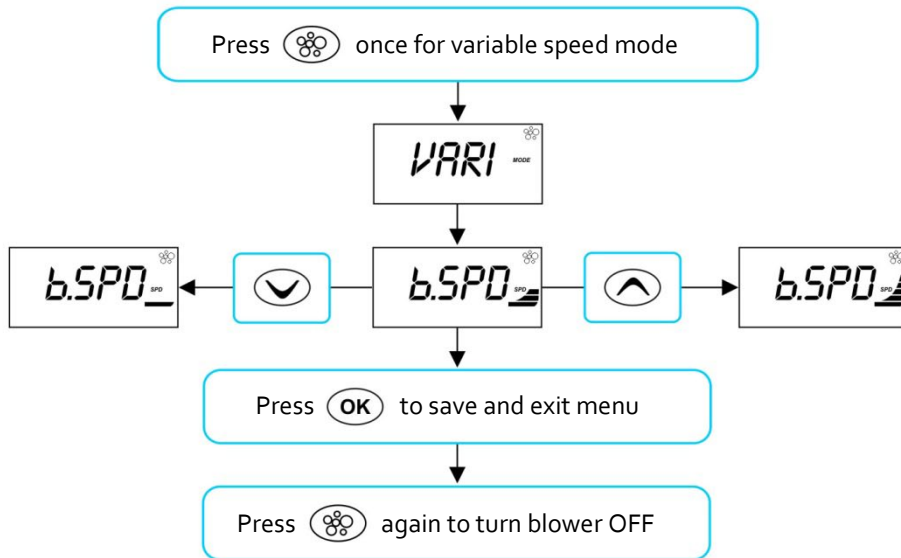

## Ramping Mode

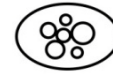
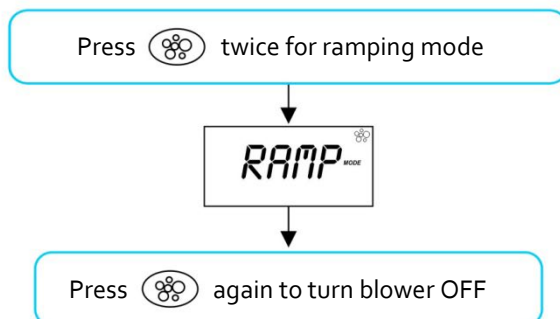





## Blower Button

The blower button is used to toggle the air blower ON/OFF and allow adjustment of the blower speed. The selected speed is saved and will be restored the next time the blower is turned on, for future ON/OFF use. Two modes of operation are provided:



### Variable Speed Mode

In this mode the blower speed can be manually adjusted to one of five (5) x different speed settings.

- ▶ Press  button once to activate blower in variable speed mode
- ▶ Display will flash **VARI** mode then present **b.SPD** (blower speed) adjustment menu (refer illustration aside)
- ▶ Press  or  buttons to increase or decrease the blower speed (note: bar graph segments adjust with blower speed)
- ▶ Press  button to exit menu or wait for 10 second display time out
- ▶ Press  button a second time to turn blower off

### Ramping Mode

In this mode the blower speed gradually increases and decreases through the blower speed range in a ramping manner.

- ▶ Press  button twice to activate blower in ramping mode
- ▶ Display will flash RAMP mode and blower operates in a ramping manner
- ▶ Press  button a second time to turn blower off

## IMPORTANT NOTES

- When blower is turned on it runs at maximum speed for 3-4 seconds before changing to preset speed (this is normal)
- If left running, blower will turn off after a 30 minute time out period. Time out period can be adjusted from 10 to 60 minutes via the Setup Menu item T.OUT (refer page 21).



## Spa Light Operation (SV2.T Models)

Multi-colour LED lighting effect modes

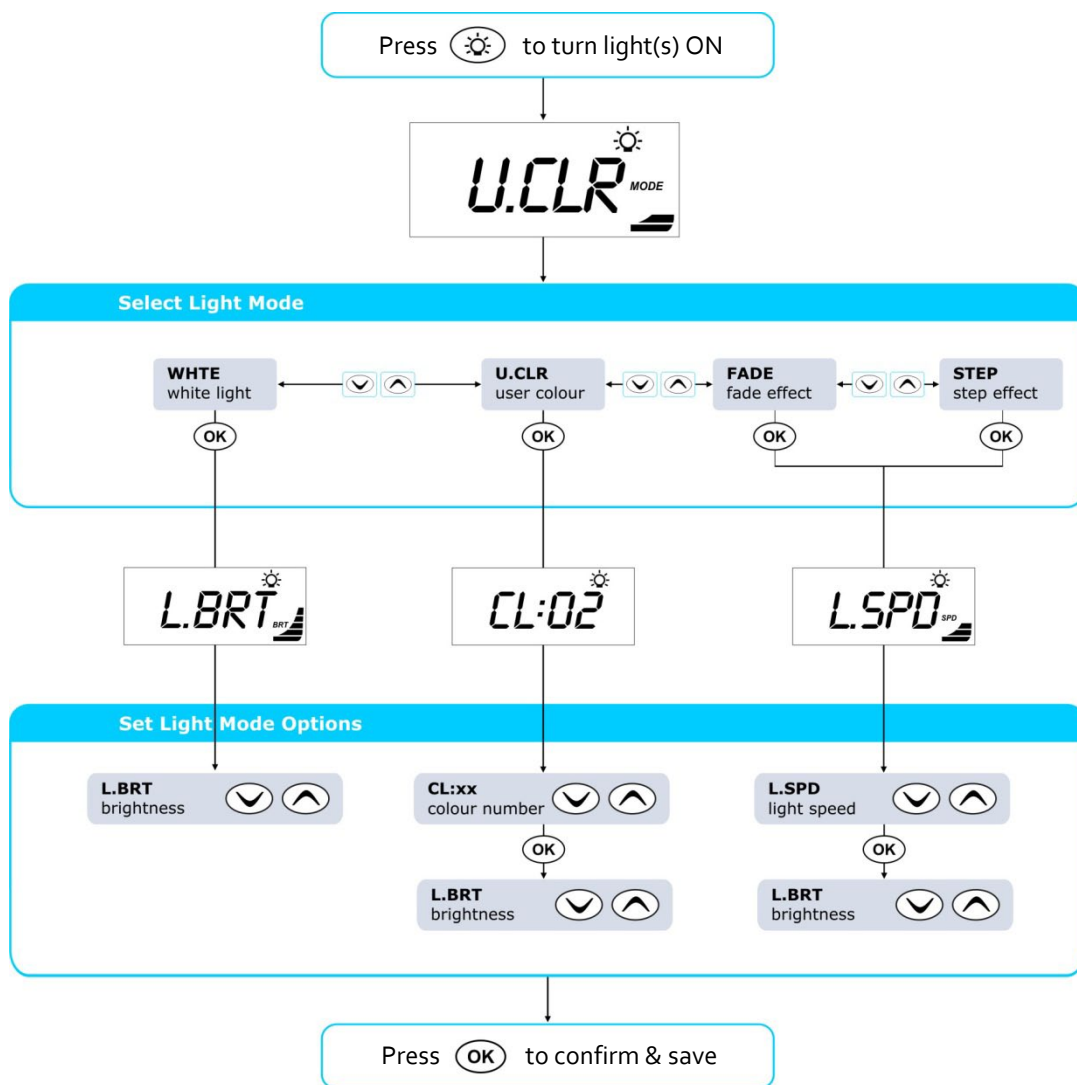

## Light Button

The light button is used to toggle the spa light(s) ON / OFF and to access the light mode menus. The features that can be adjusted are the light colour, light effect mode, light effect transition speed, and light brightness. All light settings are saved and will be restored the next time the light is turned ON, for future ON / OFF use.

- ▶ Press button to turn light(s) on / off
- ▶ When light is turned on keypad will display light mode menu showing current light mode in use (refer illustration aside)
- ▶ Press or button to navigate through choice of light modes:
 

WHITE	White Light
UCLR	User Colour
FADE	Fade Effect
STEP	Step Effect
- ▶ Press button to confirm light mode selection
- ▶ Dependant on light mode selected the keypad will display one of three light mode option screens (refer aside)
 

L.BRT	Light Brightness
CL:xx	User Colour Number (CL:00 - CL:20)
L.SPD	Light Effect Transition Speed
- ▶ Press or button to adjust each setting
- ▶ Press button to save each setting and move to the next setting

### IMPORTANT NOTES

- *If left switched on, light(s) will turn off 15 minutes after the expiry of the pump/blower time out periods.*



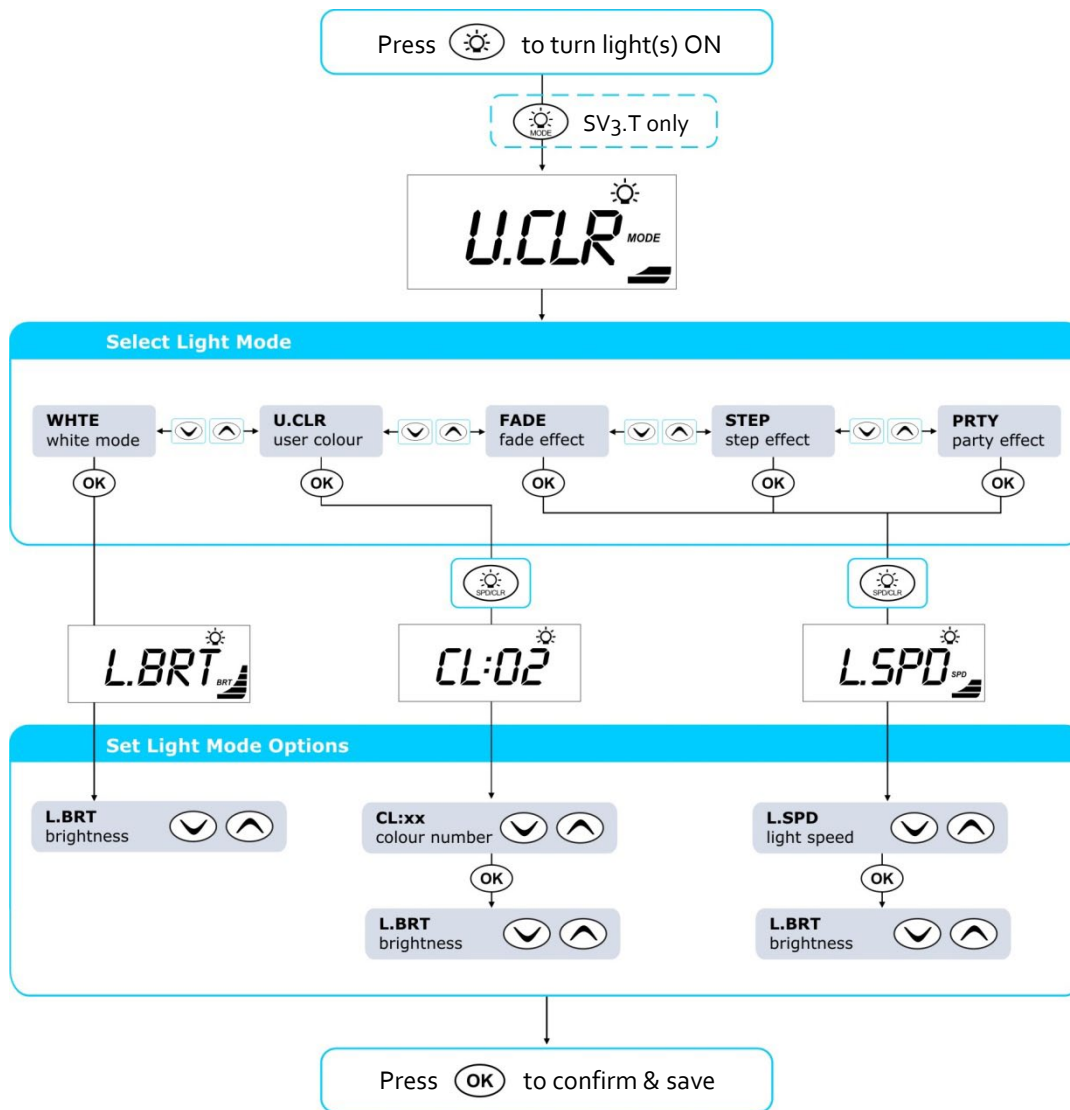

# Spa Light Operation (SV3.T / SV4.T Models)

Multi-colour LED lighting effect modes





## Light Button



The light buttons are used to toggle the spa light(s) ON / OFF and to access the light mode menus. The features that can be adjusted are the light colour, light effect mode, light effect transition speed, and light brightness. All light settings are saved and will be restored the next time the light is turned ON, for future ON / OFF use.

- ▶ Press  button to turn light(s) on / off
- ▶ SV4.T models go straight to the next step  
SV3.T models => press  to access light mode menu
- ▶ When light is turned on keypad will display light mode menu showing current light mode in use (refer illustration aside)
- ▶ Press  or  button to navigate through choice of light modes:

WHITE	White Light
UCLR	User Colour
FADE	Fade Effect
STEP	Step Effect
PRTY	Party Effect

- ▶ Press  button to confirm light mode selection
- ▶ Press  to access light speed / colour menu
- ▶ Dependant on light mode selected the keypad will display one of three light mode option screens (refer aside)

L.BRT	Light Brightness
CL:xx	User Colour Number (CL:00 - CL:20)
L.SPD	Light Effect Transition Speed

- ▶ Press  or  button to adjust each setting
- ▶ Press  button to save each setting and move to the next setting

### IMPORTANT NOTES

- *If left switched on, light(s) will turn off 15 minutes after the expiry of the pump/blower time out periods.*

## Sanitise Cycles

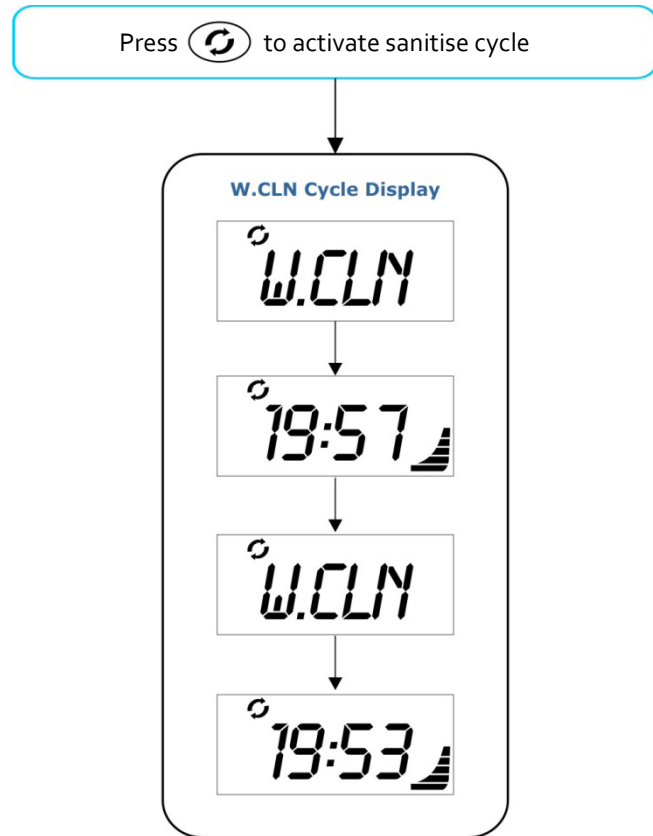

Automatic and manual water clean cycles



Whilst the cycle is running the display alternates between the W.CLN (water clean) title screen and the minutes remaining in the cycle (refer above).

## Sanitise Button

The sanitise button activates a twenty (20) minute sanitisation cycle that runs the filtration pump and ozone / uv (if fitted) to filter the pool water to restore and refresh water quality. With circ pump systems jet pump1 will also run for the full 20 minute cycle. Where 2-speed filtration pumps are used the pump will run in high speed for the duration of the cycle. In addition, at the start and end of the cycle, the controller will sequentially (one at a time) run any additional pumps (pump2, pump3, pump4 if fitted) and the blower for one minute each to purge the plumbing and clear any unfiltered water trapped in those lines.

- ▶ Press  button to activate a 20 minute sanitise cycle
- ▶ Press  button again to cancel cycle (if desired)

### IMPORTANT NOTES

- When the cycle is started automatic mode is enabled and if running any additional jet pumps and the blower are turned off.
- If the controller falls within a designated sleep or power save period during a sanitise cycle, the controller will not sleep until the sanitise cycle is finished.

### Automatic Daily Sanitise Cycle

The controller will automatically run a 10 minute sanitise cycle every day at a user adjustable time (Default = 9:00am). The automatic sanitise cycle works in the same manner as a manual sanitise cycle excepting that the cycle only runs for 10 minutes. This feature cannot be disabled – only the time this cycle is activated may be changed via the Setup Menu item W.CLN (refer pages 21 & 22).

### IMPORTANT NOTES

- If the controller is in a sleep period at the specified automatic sanitise cycle time, it will wait until the sleep period ends before the sanitise cycle runs.
- If the spa pool is in manual use (i.e. the loads have not timed out and the spa has not returned to auto mode) at the time the automatic sanitise cycle is set to run the cycle will be cancelled for that day.

## Special Function Buttons

Model specific function buttons

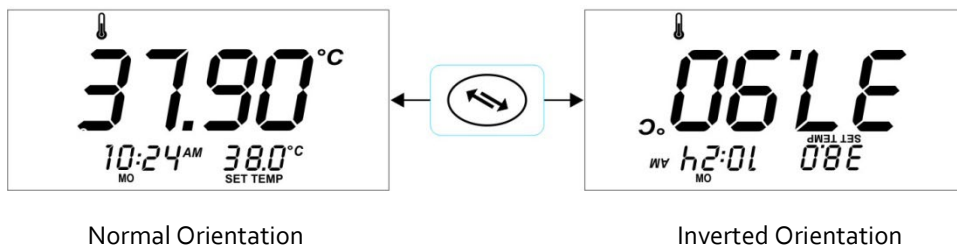
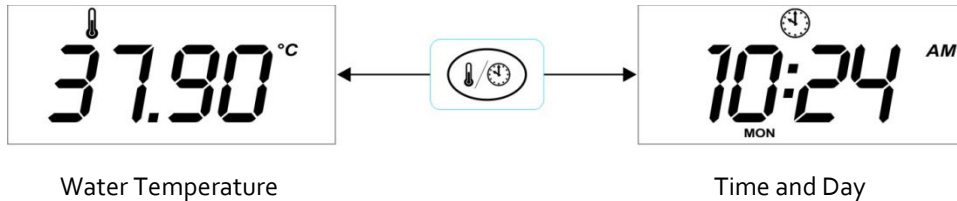

## SV2 Models



### Water Temp / Time Toggle Button

Featured on SV2 models only, this button is a shortcut key designed to quickly toggle the display mode between [W.TMP] Water Temperature or [TIME] Time & Day display modes.

## SV3 / SV4 Models





### Invert Display

On SV3 and SV4 model controllers the orientation of the keypad display can be inverted (flipped 180°) for easy reading in and out of the spa.

▶ Press  button to invert display orientation

## IMPORTANT NOTES

- The operation of the  and  buttons also reverse to match the current display orientation.
- If the display is left in the inverted orientation, the display will change back to the default direction 15 minutes after the pump/blower time out period has elapsed and controller returns to automatic mode.

# Keylock Function

How to set full or partial keylock

## Full Lock

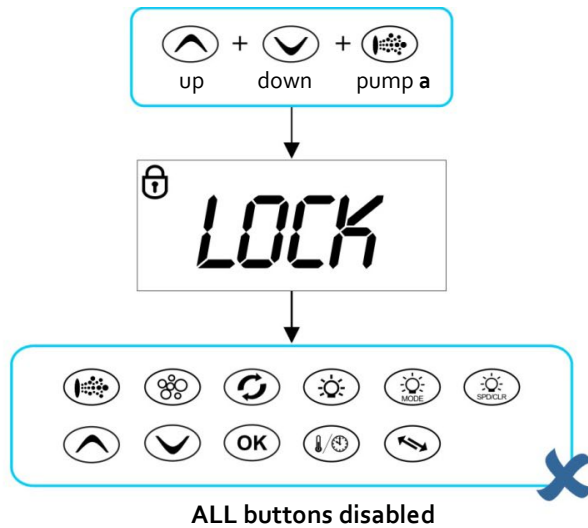

## Partial Lock

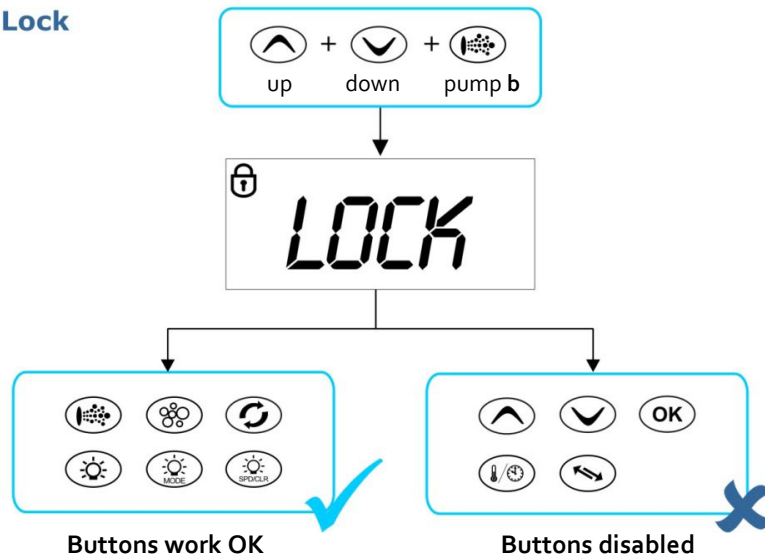

The keypad buttons can be locked to prevent accidental key presses or to limit access to certain controller functions. This feature is particularly helpful when spa covers are used or where children are present.

There are two types of keylock:

- Full Lock all buttons are disabled
- Partial Lock allows use of pumps, blower, light and sanitise buttons however prevents adjustment of set temperature and other programmable settings

## Full Lock

- ▶ Press and hold up + down + pump a until LOCK appears on the display
- ▶ Once locked if any button is pressed the key stroke will be ignored and display will show LOCK (refer aside).
- ▶ To unlock keypad press and hold up + down + pump a

## Partial Lock

- ▶ Press and hold up + down + pump b until LOCK appears on the display
- ▶ Once locked only pumps, blower, light and sanitise buttons can be used. Access to all other buttons is disabled.
- ▶ To exit partial lock mode press and hold up + down + pump b

## Setup Menu

How to program advanced configuration settings

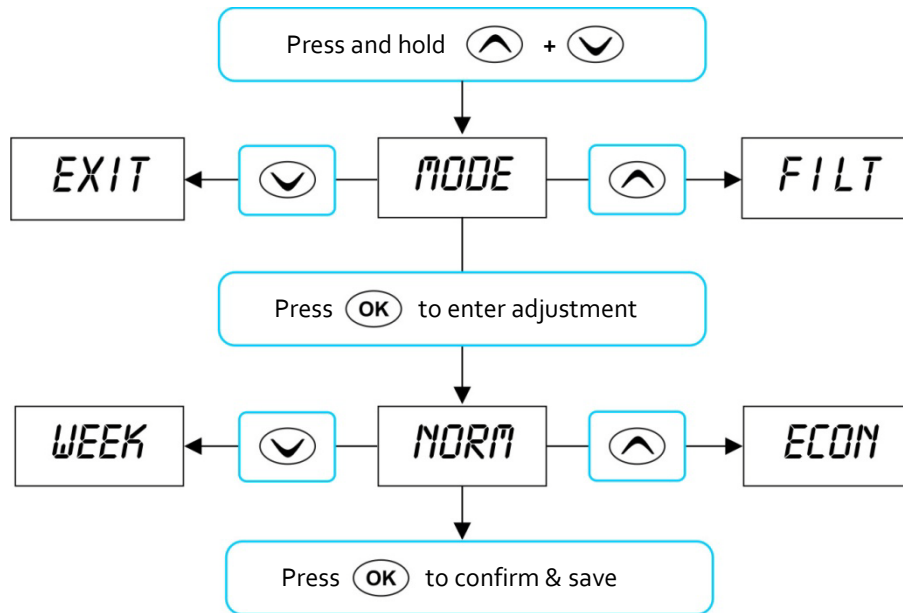

### IMPORTANT NOTES

- The setup menu item settings are stored in non volatile memory (EEPROM) and are remembered when power is turned off. No need to reprogram settings when power is restored.
- A ten (10) second idle menu time out period exists. If a button press is not detected for 10 seconds the menu will time out and the screen will return to the default display mode.

## Setup Menu

The SV controllers feature an advanced setup menu which allows customisation of the adjustable controller settings. Menu item options are detailed in the list below.

- ▶ To enter menu press and hold [Up] and [Down] buttons until [MODE] is displayed
- ▶ Press [Up] or [Down] to navigate through menu item list
- ▶ Press [OK] to enter menu item adjustment
- ▶ Press [Up] or [Down] to adjust setting
- ▶ Press [OK] to confirm setting and exit menu

Menu Item	Setting	Notes
MODE	Operating Mode	Normal / Economy / Away / Week Modes
FILT	Hours of filtration per day	1 to 24 hours
F.CYC	Filtration cycle blocks	Set filtration to run every 1,2,3,4,6,8,12 or 24 hrs
SNZE	Sleep time menu	
1.SNZ	Sleep timer 1	[1.DAY] Days of week, [1.BGN] Begin Time, [1.END] End Time
2.SNZ	Sleep timer 2	[2.DAY] Days of week, [2.BGN] Begin Time, [2.END] End Time
R.SET	Reset sleep timers	Reset sleep timers to factory defaults
EXIT	Exit sleep time submenu	
P.SAV	Power save settings	Off, Low (off-peak filtration), High (off-peak filtration & heating)
W.CLN	Automatic sanitise time	Daily run time of automatic sanitise cycle (00:00 - 23:59)
D.DIS	Default display mode	Water Temp (W.TMP), Set Temp (S.TMP) or Clock (TIME)
T.OUT	Load time out period	Pump / Blower time out period (10 to 60 minutes)
H.PMP	Heat pump operating mode	Auto (heat or cool) / Heat / Cool / Off (heat pump disabled)
H.ELE	Heat pump with SV element boost	On = Heat pump + SV element combined for heating Off = Heat pump only
EXIT	Exit setup menu	

# Setup Menu

Setup menu item details

## MODE Operating Mode

The SV controllers feature four different operating modes that effect demand heating and filtration behaviour (refer table below).

Item	Mode	Notes
NORM*	Normal	Normal operation for demand heating and filtration
ECON	Economy	Demand heating can only occur when filtration pump is running
AWAY	Away	Demand heating is DISABLED. Filtration is fixed at 1 hour per day (the keypad will scroll "AWAY MODE" every 60 secs)
WEEK	Week	Monday to Thursday: Demand heating is DISABLED and filtration fixed at 1 hour per day. Friday to Sunday: Normal Operation

\* Default Setting = NORM

## FILT Filtration (hours per day)

Automatic filtration is provided to ensure that the pool water is filtered for at least a minimum time each day after considering how often the pool has had manual use or how long the filtration pump runs for water temperature maintenance. All time spent running the pump under normal operation (manual use, water temperature maintenance, sanitisation cycles) will be taken into account and where required the pump will run for additional periods throughout the day to maintain the minimum level of daily filtration as specified by the user. SV controllers support two different types of pump for heating and filtration. The default filtration hours and adjustment limits differ for each pump type as follows:

	Small circ pump (2A or less)	Jet pump (2spd or 1spd)
Minimum filtration hrs p/day	1	1
Maximum filtration hrs p/day	24	8
Default filtration hrs p/day	4	3

## F.CYC Filtration Cycle Blocks (how often filtration cycles occur)

This setting allows the user to adjust the frequency of the filtration cycle(s). The user can set filtration blocks to occur every hour, right down to once a day, or somewhere in between.

Select filtration to occur every 1 / 2 / 3 / 4 / 6 / 8 / 12 or 24 hours  
Default setting = 4 hrs (i.e. a filtration block will run every 4 hours)

## SNZE Sleep Timers

Programmable feature to disable automatic heating and filtration to stop all spa activity during certain times of day or night (refer detailed notes on page 24).

Default Setting = Sleep Timer 1 (Sat – Fri; Sleep period 22:00 – 07:00)

## P.SAV Power Save Setting (off peak filtration and heating)

Lower daily operating costs by programming either filtration only (LOW), or both filtration and heating (HIGH) to occur during off-peak power periods when the electricity rates are cheaper (refer detailed notes on page 25).

The setting choices are: OFF / LOW (off-peak filtration) / HIGH (off-peak filtration & heating)  
Default Setting = OFF

## W.CLN Automatic Daily Sanitise Cycle Run Time

SV controllers are automatically programmed to activate a 10 minute daily sanitisation cycle at a given time, where each pump/blower is operated to purge pipe work whilst operating the filtration pump. This setting allows adjustment of the start time of the automatic daily sanitise cycle.

Setting ranges from 00:00 to 23:59  
Default = 09:00 (9AM)

# Setup Menu

Setup menu item details

## D.DIS Default Display Mode

This setting allows adjustment of the default display mode.  
The d.DIS setting choices are:

W.TMP	Water Temperature	(Default on SV3/SV4 models)
S.TMP	Set Temperature	(Default on SV2 models)
TIME	Time & Day	

## T.OUT Adjustable Load Time Out

All accessory loads (ie. jet pumps and/or air blower) automatically turn off after a time out period has elapsed. Fifteen (15) minutes later the lights will switch off and the pool will return to automatic mode. This setting allows the length of the time out period to be adjusted.

The T.OUT setting ranges from: 10 to 60 minutes  
Default = 30 minutes

## H.PMP Heat Pump Operating Mode

This setting defines the heat pump mode of operation.  
The H.PMP setting choices are:

AUTO	Heat pump will heat and cool (Default)
HEAT	Heat pump will only heat
COOL	Heat pump will only cool (SV element heating also disabled)
OFF	Heat pump disabled

## H.ELE Heat Pump with SV Element Boost

This setting defines how the in-built SV electric heating element operates with a heat pump (if fitted). Set to OFF to disable electric heating. Set to ON to allow the SV electric element to boost heat pump heating if the water temperature is 2°C or more below set temperature point or the heat pump has been operating for more than 1 hour and set point has not been achieved.

The H.ELE setting choices are:

OFF	SV element disabled (heat pump only)
ON	SV element + Heat Pump for heating

Default = OFF

## EXIT Exit setup menu

---

### IMPORTANT NOTES

- *If the ambient temperature is below the operational limit of the heat pump (-10°C) the in-built SV electric heating element will automatically be enabled regardless of the H.ELE setting.*



# [SNZE] Sleep Timer Menu

How to program sleep timers

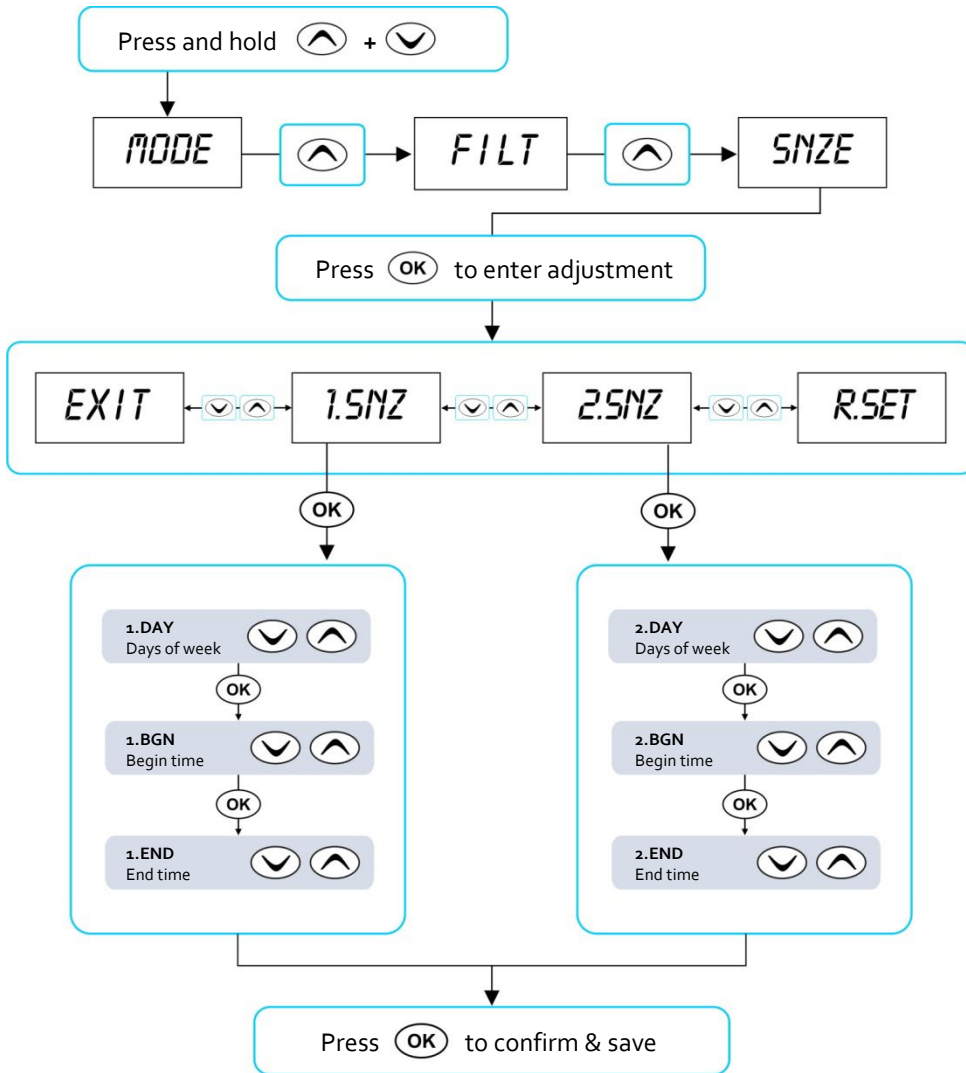

## IMPORTANT NOTES

- There is a default sleep timer pre-programmed into each SV controller. By default: Sleep Timer 1 [1.SNZ] is set to operate every day of the week (Sat – Fri) with sleep period between 22:00 (10PM) and 07:00 (7AM)
- Sleep Timers will override any programmed PowerSAVE [P.SAV] times. Spa users must consider cancelling the default sleep timer when programming P.SAV times for off-peak heating and filtration (refer page 25)
- Freeze protection will override sleep timers

Accessed via the Setup Menu, Sleep timers are a very handy feature that enables the user to stop all spa activity during certain times of day or night. While the controller is sleeping NO automatic heating or filtration maintenance will occur, however the spa can still be operated by manual use without the need to adjust sleep time settings.

There are two individual sleep timers that can be set, each of which can operate on one or more specified weekdays. This enables the user to program different sleep times for different days (ie. weekdays vs weekends), as well as custom settings on a particular day/time where the user may want the spa silenced.

- ▶ Press and hold + buttons together until [MODE] is displayed
- ▶ Press button until [SNZE] is displayed
- ▶ Press button to enter sleep timers (SNZE) adjustment
- ▶ Press or to select from [1.SNZ] Sleep Timer 1; [2.SNZ] Sleep Timer 2; [R.SET] Reset sleep times to default; [EXIT] Exit sleep menu
- ▶ Press button to confirm and move to the next setting

Each sleep time setting consists of a week day setting, start time and stop time (refer table below).

Item	Description	Notes
#.DAY	Selected day of operation	Sat / Sun / Mon / Tue / Wed / Thu / Fri Sat-Sun / Mon-Fri / Sat-Fri / : <b>Default = Sat-Fri</b> (Note : = disabled)
#.BGN	Begin Time Sleep time period begins	Adjustable: 00:00 - 23:59 <b>Default = 22:00 (10PM)</b>
#.END	End Time Sleep time period ends	Adjustable: 00:00 - 23:59 <b>Default = 07:00 (7AM)</b>

- ▶ Press or to adjust each setting
- ▶ Press button to confirm setting and move to the next setting

## [P.SAV] PowerSAVE Menu (off-peak)

How to program off-peak filtration and heating

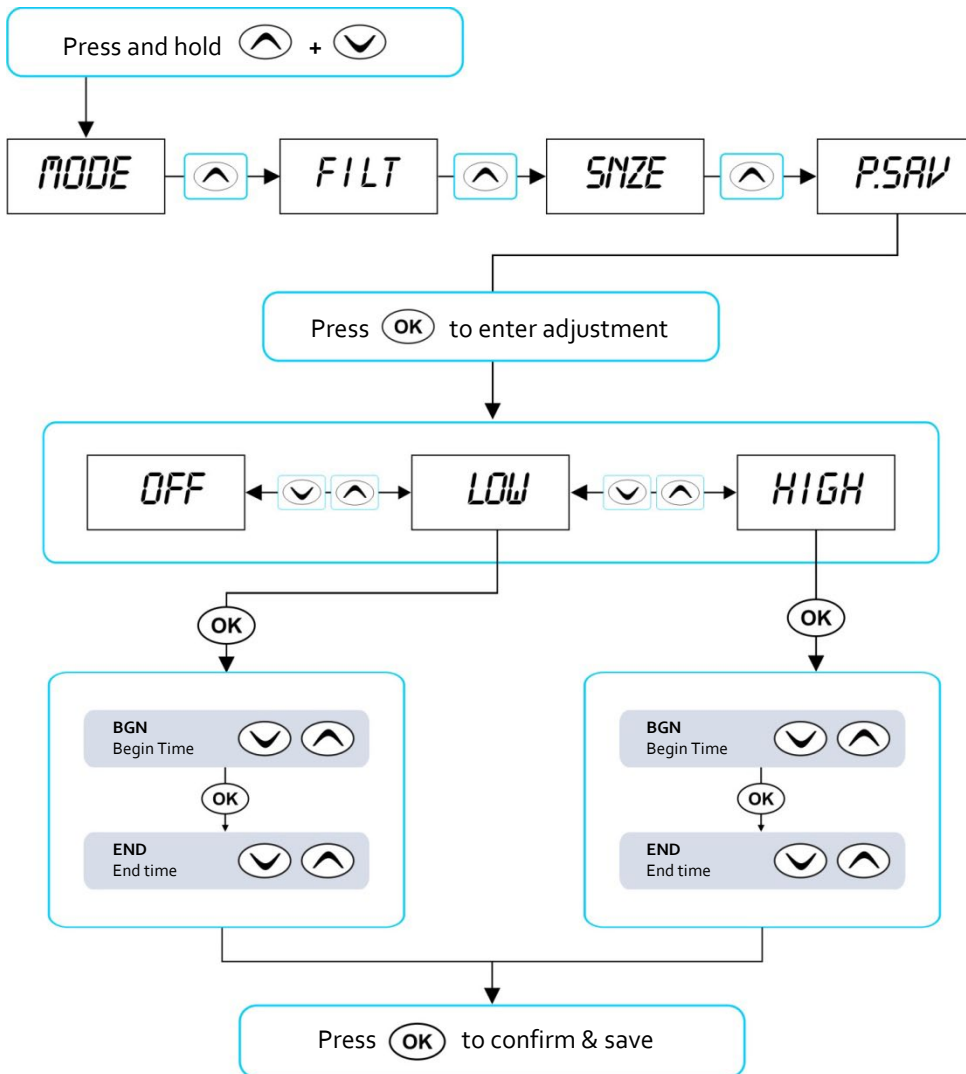

Power utilities in some regions offer household power meters that can track power usage during different times of the day. This allows the utilities to offer greatly reduced power pricing during off peak power times. The Power Save (P.SAV) function allows the user to program in the peak power period so the spa control knows not to perform filtration and/or heating during those expensive hours. Instead the controller will take advantage of the competitively priced off peak hours, and run the filtration and/or heating during the off peak hours.

- ▶ Press and hold and buttons together until [MODE] is displayed
- ▶ Press button until [P.SAV] is displayed
- ▶ Press button to enter power save (P.SAV) adjustment

The power save setting consists of a choice of mode, peak power period start time and peak power period end time (refer table below).

Item	Description	Notes
P.SAV	Power Save Mode Functions disabled during peak power periods	<b>OFF = P.SAV disabled (default)</b> LOW = Filtration disabled HIGH = Filtration & Heating disabled
BGN	Begin Time Peak power period begins	Adjustable: 00:00 - 23:59 <b>Default = 14:00 (2PM)</b>
END	End Time Peak power period ends	Adjustable: 00:00 - 23:59 <b>Default = 20:00 (8PM)</b>

- ▶ Press or to adjust each setting
- ▶ Press button to confirm each setting and move to the next setting

### IMPORTANT NOTE

*If P.SAV function is to be used the spa user MUST consider any sleep timers [SNZE] and adjust them accordingly. Sleep timer settings will OVERRIDE any P.SAV settings. All SV controllers have a default sleep timer (Sat – Fri; Sleep period 22:00 – 07:00). If P.SAV is set and the default sleep timer is not adjusted the spa controller may have insufficient awake hours for water temperature maintenance. Refer to page 24 for further details regarding sleep timers.*

## Error Codes & Troubleshooting Problems

How to troubleshoot spa problems

SV spa controllers feature self diagnostics and scrolling error messages to quickly troubleshoot possible problems. Should the spa control encounter a problem the error code / message will scroll across the topside panel screen until the problem is resolved. If an error condition is experienced all spa functions are shut down and the spa should not be used until the error condition has been resolved. A list of error codes with descriptions of problems and possible solutions is detailed below for your reference.



### IMPORTANT NOTE

**For most error codes mains power to the spa control must be turned OFF and then back ON before the error condition will be cleared.**

### Heartbeat LED

All SV model spa packs feature a red flashing heartbeat LED light. The heartbeat LED is located on the front right hand side of the spa pack itself (installed underneath spa skirt).

The heartbeat LED flashes to indicate the current health/status of the spa pack. When the spa pack is functioning correctly with no errors to report the heartbeat LED emits a single flash in a constant pulse much like a heartbeat (ON, OFF, ON, OFF). If the spa pack encounters a fault the heartbeat LED will begin flashing in sequence with the error code number being experienced (ie. ER2 = ON,ON; OFF ON,ON; OFF).

If the keypad display is ever blank a spa user can still determine the health / status of the SV controller by removing a panel from the spa skirt and checking the heartbeat LED on the front of the spa pack itself.

### ER-2 HEATER PLUG

Problem: No heater sensor communication

Cause: Internal heater sensor communication problem

Solutions:

- Turn mains power OFF, wait 5 minutes then restart spa
- Contact spa reseller if problem is not resolved with power reset

### ER-3 WATER PRIME

Problem: Water prime failed – air detected in heater tube

Cause: Airlock in pipe work, low water level, dirty filter cartridges

Solutions:

- Press Pump A button to retry water prime
- Check spa water level (refill if necessary)
- Remove filter cartridges and press Pump A button to retry prime
- Bleed airlock from pipe work by slightly loosening couplings on front of filtration pump
- Remove filter cartridges and flush water down pipe work with a hose

### ER-4 THERMAL TRIP

Problem: Heater thermal trip activated. Heater has been active and has had insufficient water flow over the element. Low or no water flow has caused the heater temperature to exceed its maximum limits and the spa control has shut down operation to prevent any damage to the heater unit

Cause: Low water level, airlock in pipe work, closed shut-off valves, dirty filter cartridges, filtration pump failed or operation intermittent

Solutions:

- Turn mains power OFF and wait 10-15 minutes for element to cool and thermal cut-out device to reset. Then turn power back ON
- Check spa water level (refill if necessary)
- Remove filters and clean as per manufacturer's recommendations or replace cartridges if required
- Check under spa cabinet to ensure all shut-off valves are in the OPEN position
- Bleed airlock from pipe work by slightly loosening couplings on front of filtration pump or by removing filters and flushing water down pipe work with a hose.

# Error Codes & Troubleshooting Problems

How to troubleshoot spa problems

## ER-5 POOL TOO HOT

- Problem:** Pool over temperature. Temperature sensor reading  $\geq 45^{\circ}\text{C}$
- Cause:** High ambient temperatures (especially in summer months) have caused water temperature to rise above set temp point, Excessive filtration time, Jet pumps have been operating for extended periods with the spa cover still on
- Solutions:**
- Turn mains power OFF, remove spa cover, allow spa to cool then turn power back ON
  - Check daily filtration time (refer filtration section) and reduce daily filtration time if required
  - Check spa cover is not resting on topside panel buttons causing jet pumps to start when cover is on. Use keylock function to lock keypad buttons when spa not in use.

## ER-6 12V OVERLOAD

- Problem:** 12V (port) current draw over 1A limit
- Cause:** Total 12V current drawn by keypad(s), light(s), expansion ports and in pool temp sensor is excessive, 12V power supply is overloaded, too many LED light bulbs installed, faulty LED light
- Solutions:**
- Turn mains power OFF and restart spa to see if problem reoccurs
  - Reduce number of LED lights being installed
  - Systematically unplug lights, in pool temp sensor, keypads and expansion port loads from spa pack (one by one) to identify faulty part
  - Contact your spa reseller if problem persists

## ER-8 CTRL FAULT HVS

- Problem:** Heater relay is on when it should be off
- Cause:** Power surge, periods of low or high voltage, water on spa pack terminal block, relay problem
- Solutions:**
- Turn mains power OFF and back ON again to see if spa control recovers from ER8 fault
  - Inspect under spa cabinet for evidence of water leaking onto spa control. If water present, turn mains power OFF and isolate, then resolve leak, dry up excess water, and allow spa control to dry out before restoring power.
  - Contact your spa reseller if problem persists

## ER-10 OVER CURRENT

- Problem:** Mains (230V) current draw above current limit (C.LMT) detected
- Cause:** Accessory devices current draw is too large for the C.LMT setting, faulty jet pump or air blower drawing excessive current, current limit (C.LMT) settings are not configured to match circuit breaker rating, load shed (L.SHD) and/or load limit (L.LMT) settings incorrect
- Solutions:**
- Turn mains power OFF and back ON again
  - Check operation of each pump => attempt to identify problematic pump or blower causing ER10 to occur
  - Contact your reseller to check controller settings are configured to match available power and circuit breaker rating

## Heat Pump Error Codes

Understanding heat pump error codes

### HEAT PUMP ERROR CODES

If an optional heat pump is fitted and a heat pump fault condition is detected a warning message is scrolled across the touch pad LCD every 60 seconds and the heat pump is disabled.

Spa operation will continue however the spa will now heat with the inbuilt SV electric element and there will be no ability to cool the water. The heat pump warning message will continue to scroll every 60 seconds, and the heat pump will remain disabled until the mains power is turned OFF and back ON again.

If after resetting mains power the fault condition persists please contact your spa reseller and report the warning message that is shown. A list of the fault conditions and warning messages are detailed below for reference.

WARNING MESSAGE	DESCRIPTION
"HEAT PUMP AMB"	Ambient thermistor temperature sensor error
"HEAT PUMP COND"	Condenser thermistor temperature sensor error
"HEAT PUMP FLOW"	Water flow not detected
"HEAT PUMP LOW P"	Compressor low pressure switch open
"HEAT PUMP HIGH P"	Compressor high pressure switch open
"HEAT PUMP COMP"	Compressor thermal cut out open
"HEAT PUMP EXCH"	Heat exchanger thermal cut out open



### IMPORTANT NOTE

If a heat pump encounters an error the heat pump will remain disabled until the mains power to the SV spa controller is turned OFF and back ON again. The heat pump warning message will continue to scroll every 60 seconds until the power is reset.

## Maintenance Timers

### SERVICE REMINDER MESSAGES

Certain spa manufacturers will choose to take advantage of the inbuilt service timer reminders available within the SV controller software. Maintenance reminders such as "SERVICE FILTERS" can be programmed to scroll across the screen every 60 seconds after a certain time period has elapsed.

**If your keypad display begins scrolling a service reminder every 60 seconds this message can be cancelled/reset by pressing the OK button whilst the service message is scrolling.**

### SERVICE FILTERS

A default service reminder that is often programmed to occur every 2 or 4 weeks. This reminder is to prompt the spa owner to thoroughly clean and service their spa filters. Depending on type of filter cartridge(s) installed the filters will either require cleaning, soaking in a filter cartridge degreaser solution or replacing. Refer to spa reseller/manufacturer for details on type of filter cartridge(s) installed and recommended cleaning methods.

### How to cancel "Service Filters" scrolling message

Press OK button whilst "Service Filters" message is scrolling across display

## Contact Us

Spa Net Head Office Contact Details

### Spa Net Pty Ltd

Unit 4  
103 Railway Road North  
Mulgrave NSW 2756  
Australia

Phone: +61 2 4587 7766  
Fax: +61 2 4587 8766

**[www.spanet.com.au](http://www.spanet.com.au)**

Technical Support & Service [service@spanet.com.au](mailto:service@spanet.com.au)

Accounts Department [accounts@spanet.com.au](mailto:accounts@spanet.com.au)

Sales Department [sales@spanet.com.au](mailto:sales@spanet.com.au)