

Cabinet Free Cover Basket Instructions

1	Base Plate 1pc	16	PVC Push Cap 22pcs
2	Left Support Leg 1pc	17	M8-X40 Hex Bolt 2pcs
3	Right Support Leg 1pc	18	M8 Flower Hex Nut 2pcs
4	Base Plate Bracket 1pc	19	1/2" PVC Cap 4pcs
5	Main Support Frame 1pc	20	Safety Locking Cable 1pc
6	Gas Cylinder 1pc	21	Pivot Steel Bushing 2pcs
7	Main Tube Frame 1pc	22	Rubber Washer 2pcs
8	Right Turnable Arm 1pc	23	M8 Round Head Hex Bolt 2pcs
9	Left Turnable Arm 1pc	24	5x18mm Screw 12pcs
10	Adjustable Arm 2pcs	25	Rubber Plug 4pcs
11	M8 Hex Nut 2pcs	26	Rubber Cushion 2pcs
12	M8 Hex Bolt 6pcs	27	Stopper Pin 2pcs
13	5x80mm Wood Screw 4pcs	28	Adjustable Arm Cap 2pcs
14	M8 Round Head Hex Nut 4pcs	29	5x30mm Wood Screw 6pcs
15	M8 Washer 6pcs		

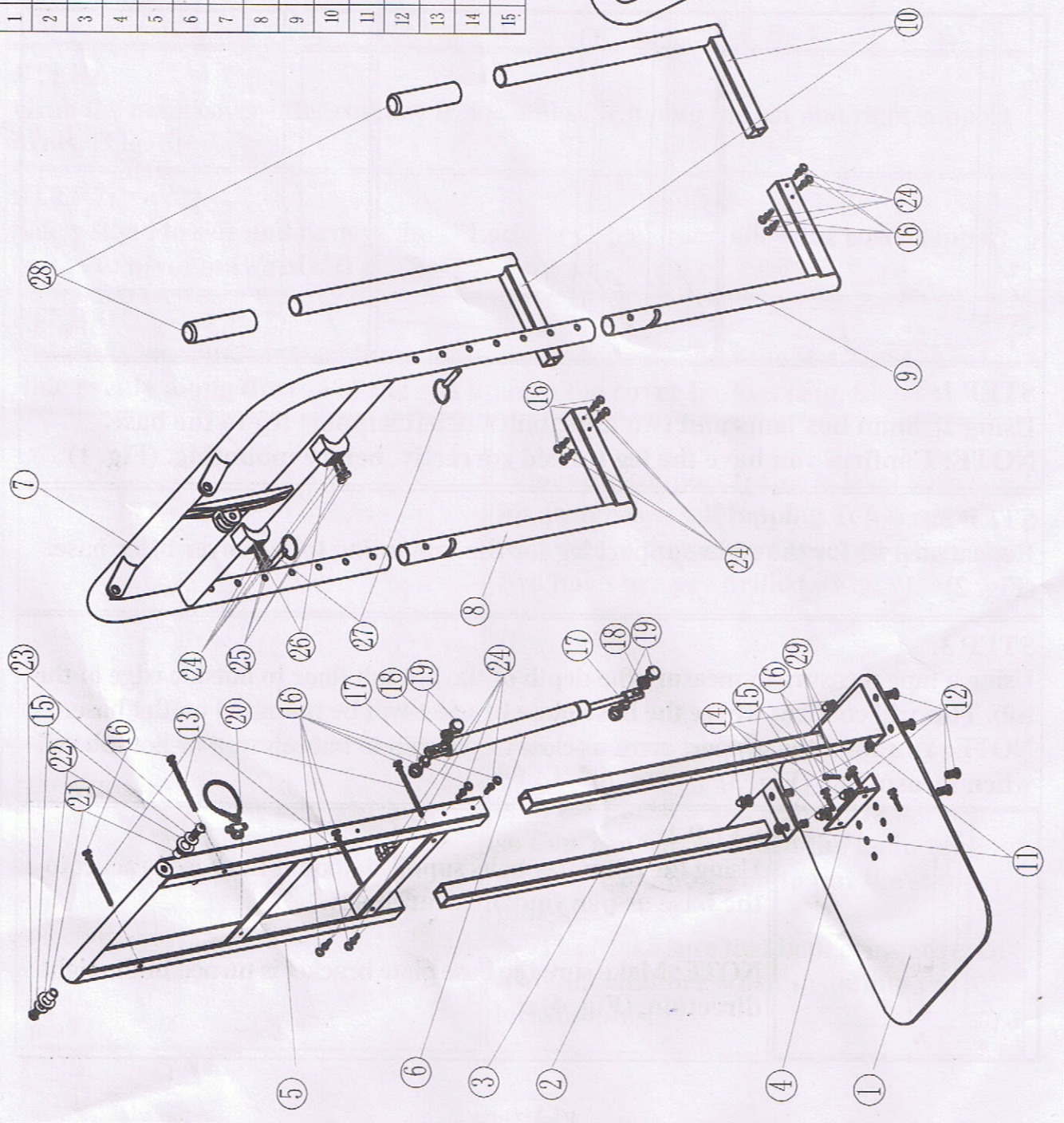

Cabinet Free Cover Basket Instructions

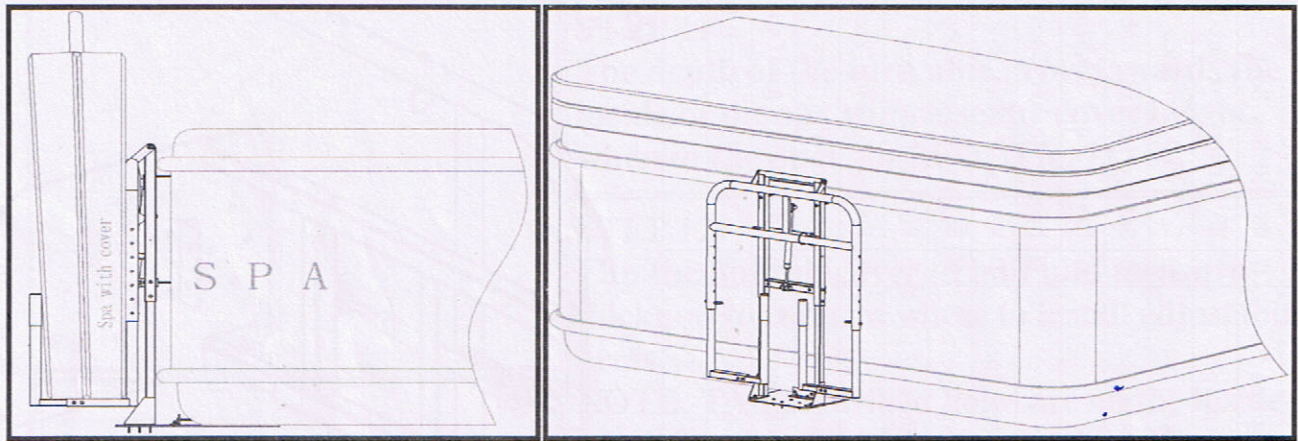

***Make sure that you have all the parts from the parts list**

***Note: All left and right directions are from standing in front of Hot Tub**

***Note: Recommendation to pre drill cabinets before installing wood screws with the drill bit supplied to prevent cabinet damage**

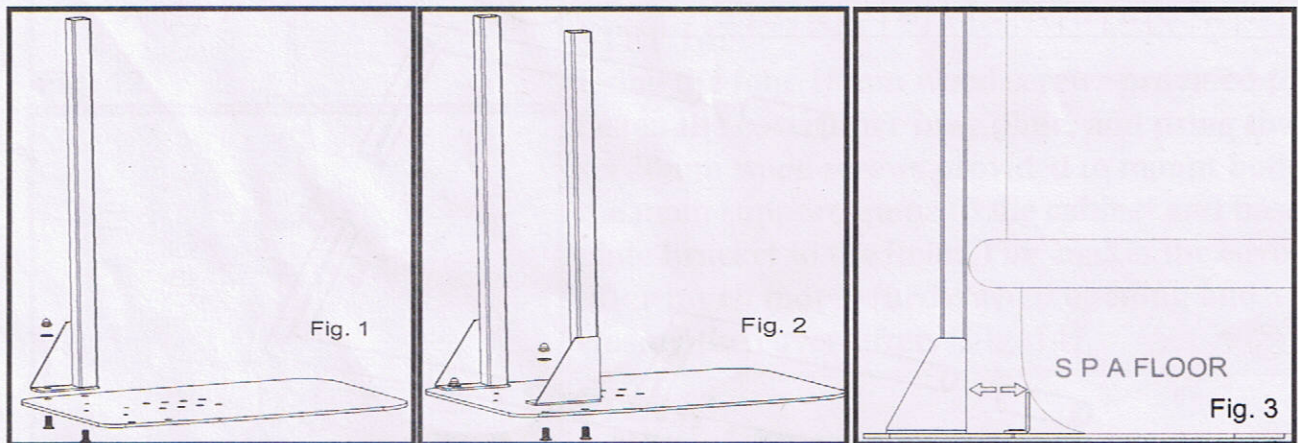

STEP 1:

Using 2 \square 8mm hex bolts and two nuts, bolt the left support leg to the base.

NOTE: Confirm you have the leg turned correctly before mounting. (Fig. 1)

STEP 2:

Repeat step #1 for the right support leg for the mounting to the cover lifter base. (Fig. 2)

STEP 3:

Using a tape measure to measure the depth of the hot tub floor to outside edge of the tub. This will confirm where the base plate bracket will be mounted on the base.

NOTE: You want the support arms as close as you can to hot tub wall or hot tub rail when measuring. (Fig. 3)

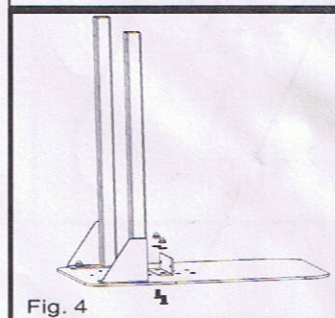

STEP 4:

Using the 8mm hex bolts supplied, mount the base bracket to the base as per your measurement.

NOTE: Make sure the base plate bracket is turned in the right direction. (Fig. 4)

Cabinet Free Cover Basket Instructions

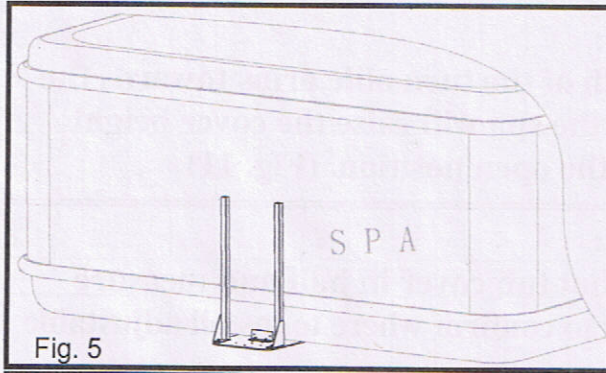

Fig. 5

STEP 5:

Now using a spa wedge “Not Supplied” . Lift the spa up and slide the cover lifter base under the spa until the base plate is flush with the hot tub floor vertically.

NOTE: When lifting the spa make sure that you center the cover lifter base on the spa. (Fig. 5)

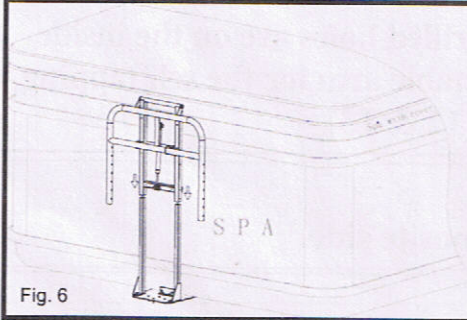

Fig. 6

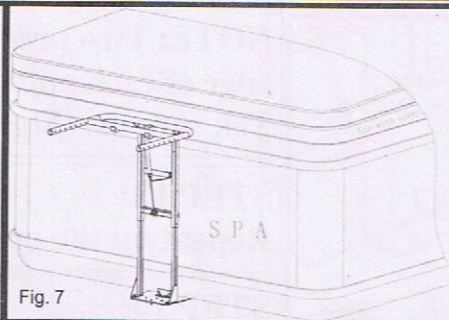

Fig. 7

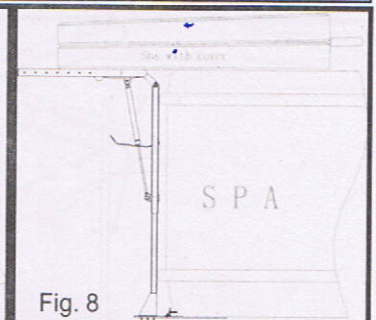

Fig. 8

STEP 6:

Grab the main cover lifter support frame and slide it onto the left and right support arms. (Fig. 6)

STEP 7:

Safely stand to side and remove the “Locking Cable” and allow the cover support frame to pivot outwards. (Fig. 7)

STEP 8:

Slide the cover lifter support frame either up or down to allow the Hot Tub Cover to slide evenly along the top of the spa lip into the cover basket. (Fig. 8)

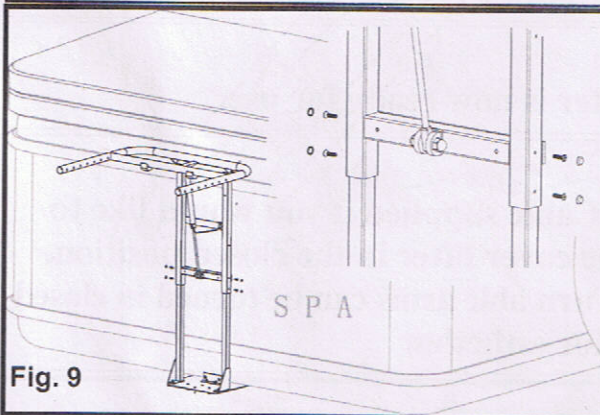

Fig. 9

STEP 9:

When the support frame is level with spa lip, fasten two self tapping Tek screws on each side of the support brackets where the two holes are pre drilled. (Fig. 9)

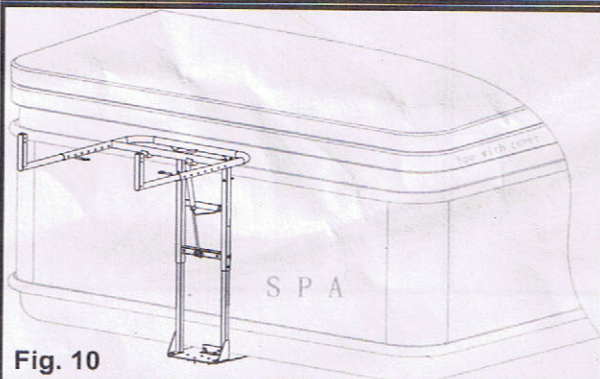

Fig. 10

STEP 10:

Now turn the left and right turntable arms so they are vertical with the main tube assembly to allow you to put the stopper pins in.

NOTE: Make sure that both arms are even with one another when installing the locking pins.

Cabinet Free Cover Basket Instructions

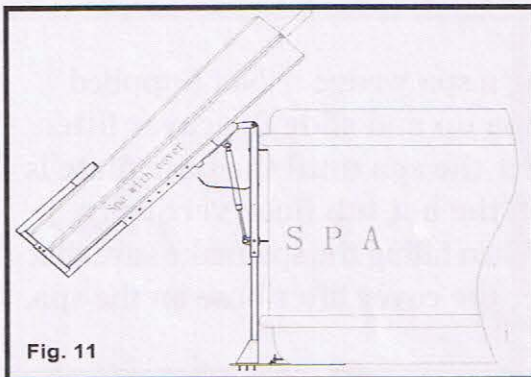

STEP 11:

The depth of the turn able arms towards the inside of the spa will raise the cover height when in the open position. (Fig. 11)

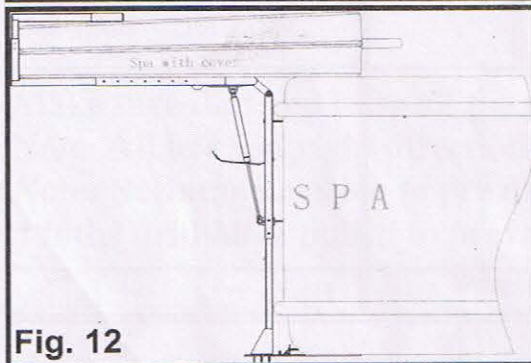

STEP 12:

Flip the hot tub cover in half and measure thickness to confirm where to install adjustable arms.

NOTE: Two predrilled holes are on the inside edge of each adjustable arm for the self tapping Tek screws. (Fig. 12 & 13)

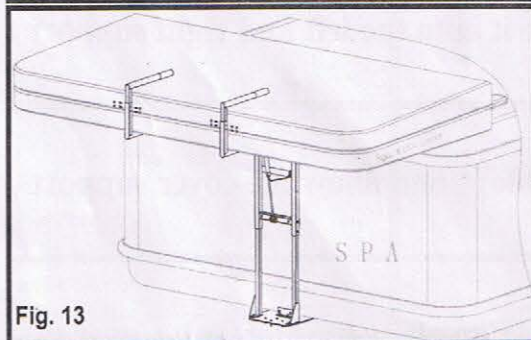

STEP 13:

Repeat on the opposite side.

STEP 14:

Using the four 18mm wood screws provided to fasten the cover lifter base plate, and using the six 30mm wood screws provided to mount both the main support frame to the cabinet and base plate bracket to the floor. This makes the cover lifter much more sturdy when opening and closing the cover lifter. (Fig. 14)

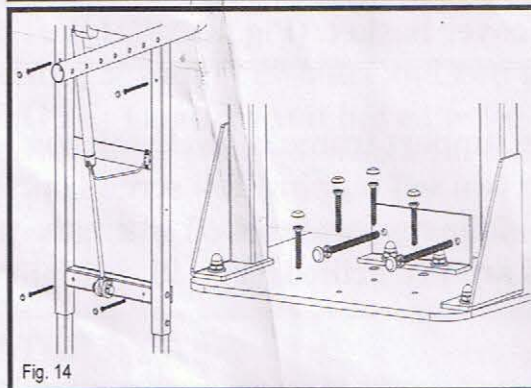

STEP 15:

Now apply all black PVC caps to screws and Bolts.

STEP 16:

Cover lifter is now ready for use.

STEP 17:

Locking Cable supplied if you would like to secure the cover lifter in the closed position.

NOTE: Turn able arms can be turned in closed position for esthetics.

