

How to measure your spa cover correctly

C

Measuring location of catches

Measure distance (T1 & T2) from each outer spa edge to centre of catch. If more than one catch per side also measure distance between catches (T3). Then measure from top of the spa (**not the spa cover**) down to center of catch (T4).

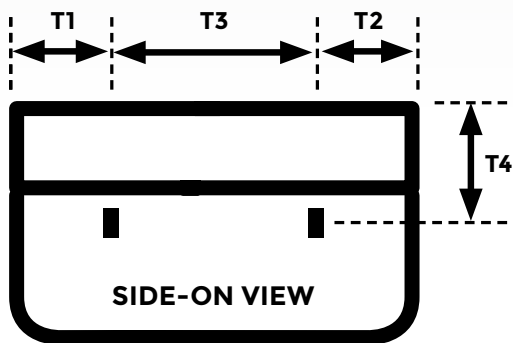

R

Measuring the outer radius

Measure from beginning of curve (R1) to point where both straight rules meet (R2)

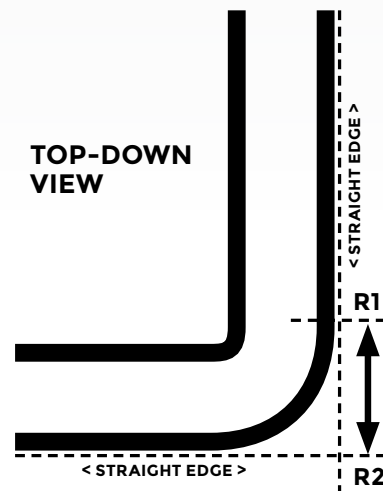

S

Measuring each side

Measure the outside dimensions of your spa.

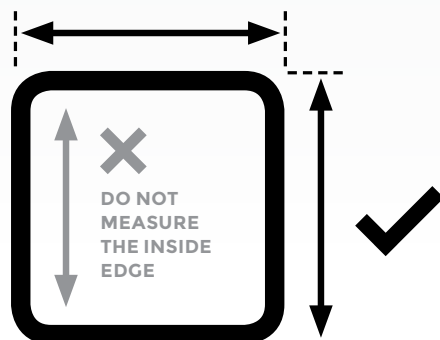

L

Measuring the lip

Measure from top surface of spa shell down to where it meets cabinet, deck or tile.

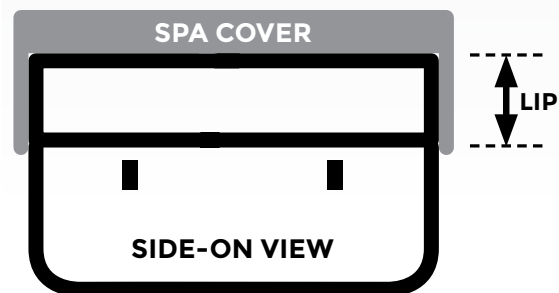



Spa Cover Construction

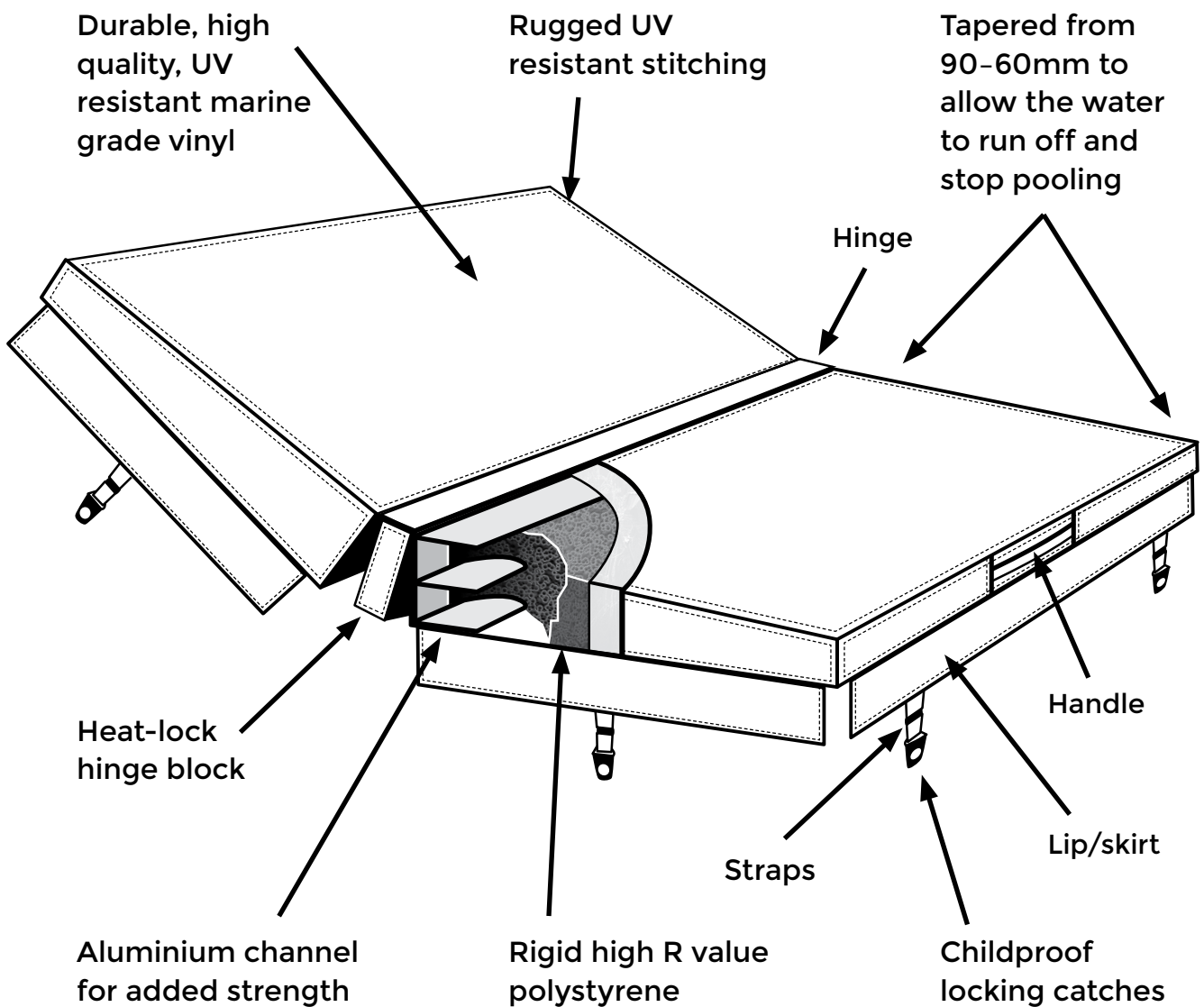

NOTE:

Stock and generic covers may have different latch locations. All covers include new locking latches. If the latch placement does not match yours, you may have to install the new latches in a different location.

Contact us for a custom cover if you need specific latch placement.

SPA STORE AUSTRALIA

CALL 1300 556 558 EMAIL HELP@SPASTORE.COM.AU WEB WWW.SPASTORE.COM.AU

SPA COVER ORDER FORM — SCAN AND EMAIL TO SPA STORE

EMAIL HELP@SPASTORE.COM.AU CALL 1300 556 558

Name: _____ Spa Store Order # (For Office Use) _____

Email: _____ Phone: _____

Address: _____

View how to measure your spa cover video: <https://youtu.be/K5G7ZZayGq8>

[CLICK TO WATCH VIDEO](#)

What shape is your spa? Tick A, B, C or Other



A

 A



B

 B



C

 C

Other*

*If other shape, please go to page 4

Which way does the hinge on your cover run?

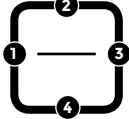

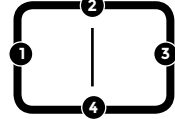

From side 1 to side 3 or From side 2 to side 4
 *Ignore this section if your spa is round.
 If other shape, please go to page 4.

R Corner Radius in mm (Required): _____

S Length of each side in mm. See the above hinge diagram for side numbers. (Required)

Side 1: _____ Side 2: _____ Side 3: _____ Side 4: _____

C Latch location in mm. See the above hinge diagram for side numbers. (Required)

NOTE: New locking latches are included with all covers. If purchasing a stock cover, you may need to drill new holes in your spa cabinet because the straps may not match the old location. If this is not acceptable, you will need to order a custom cover. T1 + T2 + T3 should equal the total length of the side with straps. If the straps are on four corners, note that instead of T1 and T2. The strap length measurement T4 is from the top of the spa (not the spa cover) down to center of catch on the cabinet.

Side 1. T1. T2. T3. T4. Side 2. T1. T2. T3. T4.

Side 3. T1. T2. T3. T4. Side 4. T1. T2. T3. T4.

L Lip Height in mm. (Required) _____

Make and model of spa if known: _____

Choose your colour **NOTE:** Colours may vary depending on screen shading and print output and are indicative only.



Slate (Charcoal)
Available on stock and premium custom covers



Chocolate
Only available on premium custom spa covers



Tan (Sandstone)
Only available on premium custom spa covers



Navy Blue
Only available on premium custom spa covers



Green
Only available on premium custom spa covers

Your signature: _____

Date: _____

By signing you are accepting and agreeing to the terms and conditions.

TERMS AND CONDITIONS SPECIFIC TO SPA COVERS:

These terms and conditions are not exclusive of but are an addition to the Spa Store Standard Terms and Conditions.

Please be advised that all of our custom spa covers are custom built for you. We build them to the dimensions supplied by you using this measurement sheet.

Measurements:

- Please read our instruction sheet and contact us if you have any questions.
- Please take extra care while taking the measurements and check them carefully before sending to us. Do ensure that they are clearly written.
- We will not accept a return, exchange or refund because of incorrect measurements supplied by you.

Colour:

- Choose the colour of your spa cover keeping in mind that the colours that you see on our site and this sheet are only representations and can look different from the actual colour because of your monitor settings.
- We will not accept a return, exchange or refund because of colour issues.

Please note: New locking cover latches are included and your old latches may need to be removed and new holes drilled for the new new latches. We cannot guarantee the exact placement of your latches.

If your spa has any other custom features that are required, you must inform us at the time you submit the measurement sheet.

By signing and dating this measurement sheet you agree with the above terms and conditions and agree that the listed dimensions and colour selection are final.

Notes:

Hex Measuring Sheet

1. MEASURE THE CRITICAL DIMENSIONS OF YOUR SPA
A, B, C, D, E, F

2. CHOOSE ONE LIP STYLE
AND PROVIDE ITS
MEASUREMENT

3. WHICH DIRECTION FOR
THE HINGE? A or B

4. PLEASE NOTE ON THE
DRAWING WHERE THE
STRAPS ARE LOCATED

5. WHAT IS THE LENGTH OF
THE TIE DOWN STRAPS?

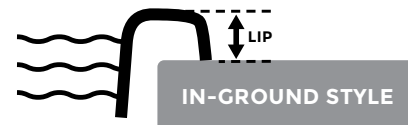
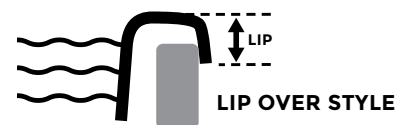
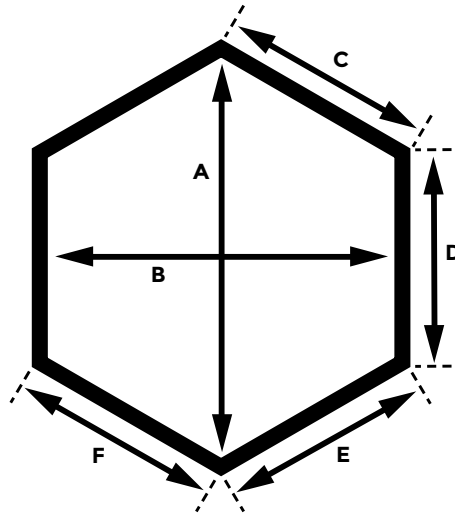

Measurements in mm: A. B. C. D. E. F.

Lip Style: _____ Lip Measurement: _____ Hinge Direction? A B Strap Length: _____

Octagonal Measuring Sheet

1. MEASURE THE CRITICAL
DIMENSIONS OF YOUR SPA
A, B, C, D, E, F

2. CHOOSE ONE LIP STYLE
AND PROVIDE ITS
MEASUREMENT

3. WHICH DIRECTION FOR
THE HINGE? A or B

4. PLEASE NOTE ON THE
DRAWING WHERE THE
STRAPS ARE LOCATED

5. WHAT IS THE LENGTH OF
THE TIE DOWN STRAPS?

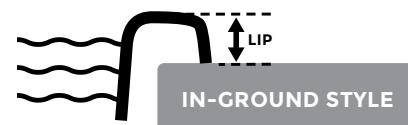
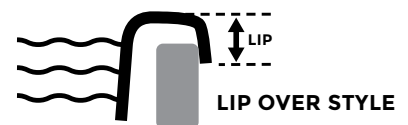
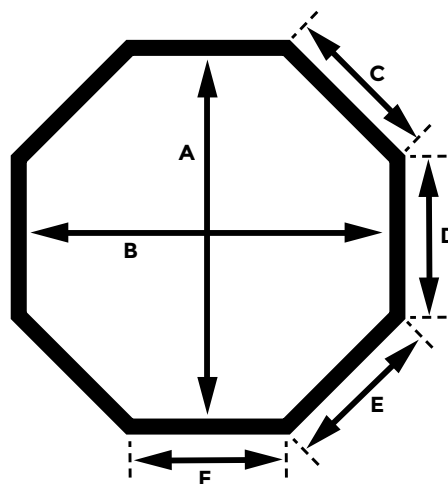

Measurements in mm: A. B. C. D. E. F.

Lip Style: _____ Lip Measurement: _____ Hinge Direction? A B Strap Length: _____